

# HITACHI

## INSTRUCTION MANUAL AND SAFETY INSTRUCTIONS

MODEL

**NV 65AF3**

NAILER

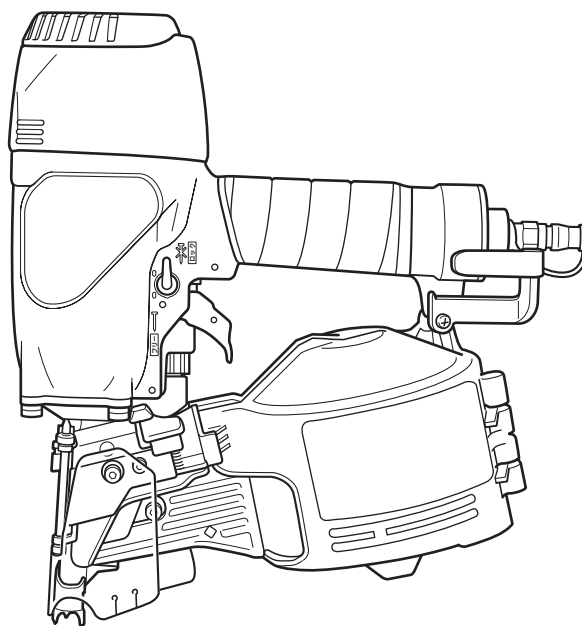

### **⚠ DANGER**

**Improper use of this Nailer can result in death or serious injury!**  
**This Manual contains important information about product safety.**  
**Read and understand this Manual before operating the Nailer.**  
**Keep this Manual available for others before they use the Nailer.**  
**Never allow anyone who has not reviewed this manual.**

## CONTENTS

IMPORTANT INFORMATION .....	3
DEFINITIONS OF SIGNAL WORDS .....	3
<b>SAFETY</b>	
IMPORTANT SAFETY INSTRUCTIONS FOR USING NAILERS .....	4
EMPLOYER'S RESPONSIBILITIES .....	6
<b>OPERATION</b>	
NAME OF PARTS .....	7
SPECIFICATIONS .....	8
NAIL SELECTION .....	8
ACCESSORIES .....	8
STANDARD ACCESSORIES .....	8
APPLICATIONS .....	9
BEFORE OPERATION .....	9
WORKING ENVIRONMENT .....	9
AIR SUPPLY .....	9
LUBRICATION .....	10
COLD WEATHER CARE .....	10
TRIGGER LOCK .....	10
TESTING THE NAILER .....	11
ADJUSTING AIR PRESSURE .....	11
LOADING NAILS .....	11
NAILER OPERATION .....	13
METHODS OF OPERATION .....	13
<b>MAINTENANCE</b>	
MAINTENANCE AND INSPECTION .....	16
SERVICE AND REPAIRS .....	17
PARTS LIST .....	19

## **IMPORTANT INFORMATION**

**READ AND UNDERSTAND ALL OF THE OPERATING INSTRUCTIONS, SAFETY PRECAUTIONS AND WARNINGS IN THIS MANUAL BEFORE OPERATING OR MAINTAINING THIS NAILER.**

**Most accidents that result from the operation and maintenance of Nailers are caused by the failure to observe basic safety rules or precautions. An accident can often be avoided by recognizing a potentially hazardous situation before it occurs, and by observing appropriate safety procedures.**

**Basic safety precautions are outlined in the "SAFETY" section of this Manual and in the sections which contain the operation and maintenance instructions.**

**Hazards that must be avoided to prevent bodily injury or machine damage are identified by DANGERS and WARNINGS on the Nailer and in this Manual.**

**Never use this Nailer for applications other than those specified in this Manual.**

## **DEFINITIONS OF SIGNAL WORDS**

**DANGER** indicates an imminently hazardous situation which, if not avoided, will result in death or serious injury.

**WARNING** indicates a potentially hazardous situation which, if not avoided, could result in death or serious injury.

**CAUTION** indicates a potentially hazardous situation which, if not avoided, may result in minor or moderate injury, or may cause machine damage.

**NOTE** emphasizes essential information.

# SAFETY

## IMPORTANT SAFETY INSTRUCTIONS FOR USING NAILERS

### READ AND UNDERSTAND ALL INSTRUCTIONS

#### **⚠ DANGER**

##### **1. ALWAYS WEAR EYE PROTECTOR.**



When operating the Nailer, always wear eye protector with side shields, and make sure others in work area wear eye protector, too. Eye protector must conform to the requirements of American National Standards Institute, ANSI Z87.1 and provide protection against flying particles both from the front and side. The employer must enforce the use of eye protector by the Nailer operator and others in work area.

##### **2. NEVER USE BOTTLED GASES.**



Never use oxygen, combustible gases or any other bottled gases as a power source for the Nailer. Use of the above gases is dangerous, as the Nailer will explode. Use only clean, dry, regulated compressed air.

#### **⚠ WARNING**

##### **3. DO NOT EXCEED 120 psi.**

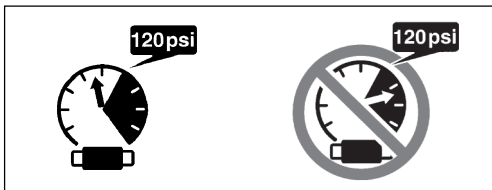

Do not exceed maximum recommended air pressure 120 psi (8.3 bar 8.5 kgf/cm<sup>2</sup>). Never connect the Nailer to pressure which potentially exceeds 200 psi (13.7 bar 14 kgf/cm<sup>2</sup>) as the Nailer can burst.

##### **4. NEVER POINT NAILER TOWARD YOURSELF OR ANYONE ELSE.**

Always assume the Nailer contains fasteners.

Never point the Nailer toward yourself or anyone else, whether it contains fasteners or not.

If fasteners are mistakenly driven, it can lead to severe injuries.

Never engage in horseplay with the Nailer.

Respect the Nailer as a working implement.

##### **5. NEVER CARRY WITH FINGER ON TRIGGER.**

Remove finger from trigger when not driving fasteners.

Never carry the Nailer with finger on trigger since you could drive a fastener unintentionally and injure yourself or someone else.

Always carry the Nailer by the handle only.

##### **6. ALWAYS WEAR EAR AND HEAD PROTECTOR.**

Always wear ear protector to protect your ears from loud noise.

Always wear head protector to protect your head from flying objects.

##### **7. STORE NAILER PROPERLY.**

When not in use, the Nailer should be stored in a dry place. Keep out of reach of children. Lock the storage area.

##### **8. KEEP WORK AREA CLEAN.**

Cluttered areas invite injuries. Clear all work areas of unnecessary tools, debris, furniture, etc.

##### **9. NEVER USE IN PRESENCE OF FLAMMABLE LIQUIDS OR GASES.**

The Nailer produces sparks during operation.

Never use the Nailer in sites containing lacquer, paint, benzene, thinner, gasoline, gases, adhesive agents, and other materials which are combustible or explosive.

##### **10. KEEP VISITORS AWAY.**

Do not let visitors handle the Nailer.

All visitors should be kept safely away from work area.

# SAFETY – Continued

## WARNING

### **11. DRESS PROPERLY.**

Do not wear loose clothing or jewelry as they can be caught in moving parts.  
Rubber gloves and nonskid footwear are recommended when working outdoors.  
Wear protective hair covering to contain long hair.

### **12. NEVER USE NON RELIEVING COUPLER ON NAILER.**

If a non relieving coupler is used on the Nailer, the Nailer can remain charged with air after disconnecting and thus will be able to drive a fastener even after disconnecting.  
The Nailer and air hose must have a hose coupling such that all pressure is removed from the Nailer when the coupling joint is disconnected.

### **13. CHECK PUSH LEVER BEFORE USE.**

Make sure the push lever operates properly. (The push lever may be called iSafetyî.) Never use the Nailer unless the push lever is operating properly, otherwise the Nailer could drive a fastener unexpectedly.  
Do not tamper with or remove the push lever, otherwise the push lever becomes inoperable.

### **14. KEEP ALL SCREWS AND COVERS TIGHTLY IN PLACE.**

Keep all screws and covers tightly mounted. Check their condition periodically.  
Never use the Nailer if parts are missing or damaged.

### **15. DO NOT LOAD FASTENERS WITH TRIGGER OR PUSH LEVER DEPRESSED.**

When loading fasteners into the Nailer or when connecting the air hose,  
1) do not depress the trigger;  
2) do not depress the push lever; and  
3) keep the Nailer pointed downward.

### **16. KEEP HANDS AND FEET AWAY FROM FIRING HEAD DURING USE.**

Never place your hands or feet closer than 8 inches (200 mm) from the firing head.  
A serious injury can result if the fasteners are deflected by the workpiece, or are driven away from the point of entry.

### **17. PLACE NAILER PROPERLY ON WORKPIECE.**

Do not drive fasteners on top of other fasteners or with the Nailer at too steep of an angle; the fasteners can ricochet and hurt someone.

### **18. BE CAREFUL OF DOUBLE FIRE DUE TO RECOIL.**

If the push lever is unintentionally allowed to re-contact the workpiece following recoil, an unwanted fastener will be driven.

In order to avoid this undesirable double fire,

- 1) do not push the Nailer on the workpiece with strong force;
- 2) take the Nailer completely away from the workpiece using recoil, and keep the push lever away from the workpiece until the next desirable shot; and
- 3) pull the trigger and release it QUICKLY when performing intermittent operation (trigger fire).

### **19. DO NOT DRIVE FASTENERS INTO THIN BOARDS OR NEAR CORNERS AND EDGES OF WORKPIECE.**

The fasteners can be driven through or away from the workpiece and hit someone.

### **20. NEVER DRIVE FASTENERS FROM BOTH SIDES OF A WALL AT THE SAME TIME.**

The fasteners can be driven into and through the wall and hit a person on the opposite side.

### **21. CHECK FOR LIVE WIRES.**

Avoid the risk of severe electrical shock by checking for live electrical wires that may be hidden by walls, floors or ceilings. Turn off the breaker switch to ensure there are no live wires.

### **22. NEVER CARRY NAILER BY HOSE.**

### **23. DO NOT OVERREACH.**

Keep proper footing and balance at all times.

### **24. NEVER USE NAILER WHICH IS DEFECTIVE OR OPERATING ABNORMALLY.**

If the Nailer appears to be operating unusually, making strange noises, or otherwise appears defective, stop using it immediately and arrange for repairs by a Hitachi authorized service center.

### **25. DO NOT DISCONNECT AIR HOSE FROM NAILER WITH FINGER ON TRIGGER.**

The Nailer can fire when re-connected to an air supply.

# SAFETY – Continued

## WARNING

### **26. TURN LOCK LEVER TO LOCK POSITION AND DISCONNECT AIR HOSE FROM NAILER WHEN:**

- 1) doing maintenance and inspection;
- 2) clearing a jam;
- 3) it is not in use;
- 4) leaving work area;
- 5) moving it to another location;
- 6) handing it to another person; and
- 7) using hook.

Never attempt to clear a jam or repair the Nailer unless you have disconnected air hose from the Nailer and removed all remaining fasteners from the Nailer.

The Nailer should never be left unattended since people who are not familiar with the Nailer might handle it and injure themselves.

### **27. STAY ALERT.**

Watch what you are doing. Use common sense.

Do not operate the Nailer when you are tired.

The Nailer should never be used by you if you are under the influence of alcohol, drugs or medication that makes you drowsy.

### **28. HANDLE NAILER CORRECTLY.**

Operate the Nailer according to this Manual.

Never allow the Nailer to be operated by children, individuals unfamiliar with its operation or unauthorized personnel.

### **29. NEVER USE NAILER FOR APPLICATIONS OTHER THAN THOSE SPECIFIED IN THIS MANUAL.**

### **30. HANDLE NAILER CAREFULLY**

Because of high air pressure in the Nailer, cracks in the surface are dangerous.

To avoid this, do not drop the Nailer or strike the Nailer against hard surfaces; and do not scratch or engrave signs on the Nailer. Handle the Nailer carefully.

### **31. MAINTAIN NAILER WITH CARE.**

Keep the Nailer clean and lubricated for better and safer performance.

### **32. USE ONLY PARTS, ACCESSORIES OR FASTENERS SUPPLIED OR RECOMMENDED BY HITACHI.**

Unauthorized parts, accessories, or fasteners may void your warranty and can lead to malfunction and resulting injuries.

Only service personnel trained by Hitachi, distributor or employer shall repair the Nailer.

Never modify or alter a nailer. Doing so may cause it to malfunction and personal injuries may result.

### **33. DO NOT REMOVE DUST COVER**

Fragments of wire collating fasteners can fly out.

### **34. CLOSE NAIL GUIDE AND DO NOT OPEN IT DURING OPERATION**

If driving fasteners with the nail guide open, the fasteners can be driven from the workpiece.

## **EMPLOYER'S RESPONSIBILITIES**

1. Ensure that this MANUAL is available to operators and personnel performing maintenance.
2. Ensure that Nailers are used only when operators and others in work area are wearing EYE PROTECTOR.
3. Enforce the use of EYE PROTECTOR by operators and others in work area.
4. Keep Nailers in safe working order.
5. Maintain Nailers properly.
6. Ensure that Nailers which require repair are not further used before repair.

**SAVE THIS MANUAL  
AND KEEP IT AVAILABLE FOR OTHERS!**

# OPERATION

**NOTE:**

The information contained in this Manual is designed to assist you in the safe operation of the Nailer.

Some illustrations in this Manual may show details or attachments that differ from those on your own Nailer.

## NAME OF PARTS

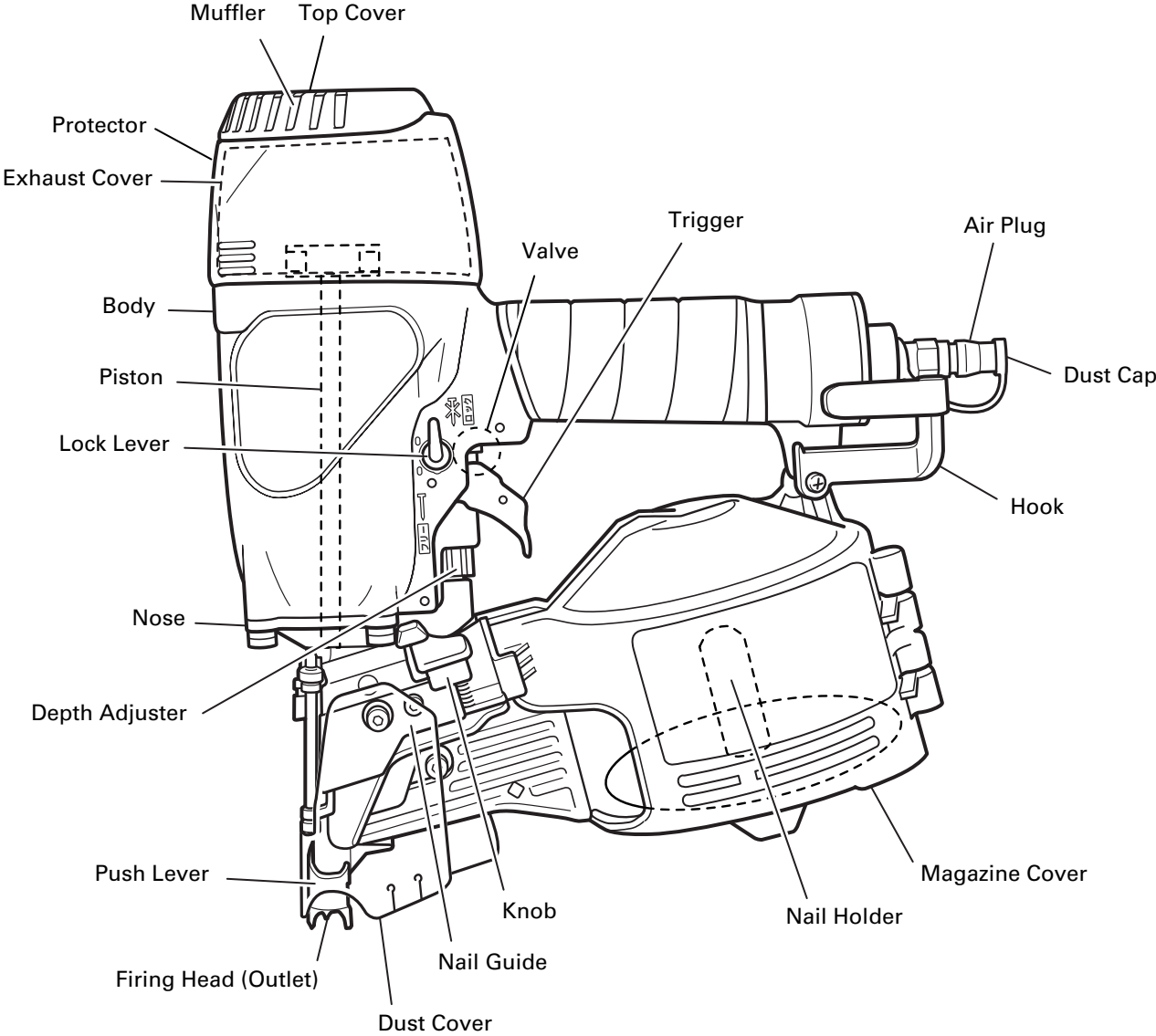

# SPECIFICATIONS

Operating pressure		0.49 – 0.83 MPa(70 – 120 psi 5 – 8.5 kgf/cm <sup>2</sup> )
Dimensions Length × Height × Width		10-13/16" × 11-5/8" × 5" (274 mm × 295 mm × 128 mm)
Weight		4.2 lbs (1.9 kg)
Applicable nail sizes	Wire collated	Length : 1-1/4 – 2-1/2" (32 – 65mm)
	Plastic sheet collated	Length : 1-1/2 – 2-1/4" (32 – 50mm)
Nail capacity		200 – 400 nails (1 coil)
Air inlet		PT 1/4 Thread

# NAIL SELECTION

Only nails shown in the Table below can be driven with this Nailer.

Wire-collated coil nails		Sheet-collated coil nails	
MIN.	MAX.	MIN.	MAX.
4.8 mm (.189")	6 mm (.236")	5 mm (.197")	6 mm (.236")
32 mm (1-1/4")	65 mm (2-1/2")	38 mm (1-1/2")	57 mm (2-1/4")
2.1 mm (0.83")	2.8 mm (.110")	2.4mm (.094")	2.8 mm (.110")

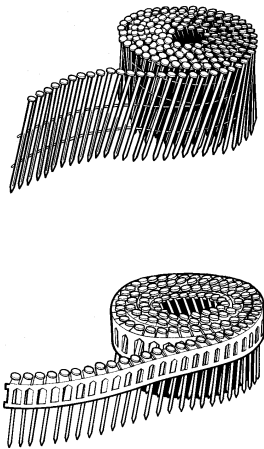

Dimensions of nails

Nails are collated and coiled, as shown in the above figure.

# ACCESSORIES

## ⚠ WARNING

● Accessories other than those shown below can lead to malfunction and resulting injuries.

### STANDARD ACCESSORIES

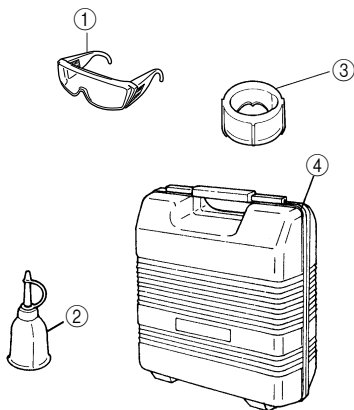

- ① Eye protector ..... 1
- ② Oiler ..... 1
- ③ Nose cap ..... 1
- ④ Case ..... 1

**NOTE:** Accessories are subject to change without any obligation on the part of HITACHI.



## APPLICATIONS

- Construction wooden works such as floor and wall framing roof decking, and subflooring.
- Mobile and modular home construction.
- Making wooden boxes, pallets, and drums.
- Packing operations in manufacturing plants, and other types of packing and crating work in general.

## BEFORE OPERATION

Read section titled **Safety (Page 4 - 6)**

Make sure of the followings before operation.

## WORKING ENVIRONMENT

### **⚠ WARNING**

- No flammable gas, liquid or other flammable objects at worksite.
- Clear the area of children or unauthorized personnel.

## AIR SUPPLY

### **⚠ DANGER**

- Never use oxygen, combustible gases or any other bottled gases.



### **⚠ WARNING**

- Never connect Nailer to pressure which potentially exceeds 200 psi (13.7 bar 14 kgf/cm<sup>2</sup>).
- Never use non relieving coupler on Nailer.

#### 1. Power source

- Use only clean, dry, regulated compressed air as a power source for this Nailer.
- Air compressors used to supply compressed air to this Nailer must comply with the requirements of the latest version of ANSI Standard B 19.3 Safety Standard For Compressors For Process Industries.
- Moisture or oil in the air compressor may accelerate wear and corrosion in the Nailer.
- Drain daily.

#### 2. Filter-Regulator-Lubricator

- Use a regulator with a pressure range of 0 – 120 psi (0 – 8.3 bar 0 – 8.5 kgf/cm<sup>2</sup>).
- Filter-regulator-lubricator units supply an optimum condition for the Nailer and extend the Nailer life.

These units should always be used.

Filter ..... The filter removes moisture and dirt mixed in compressed air.

Drain daily unless fitted with an automatic drain.

Keep the filter clean by regular maintenance.

Regulator ..... The regulator controls the operating pressure for safe operation of the Nailer.

Inspect the regulator before operation to be sure it operates properly.

Lubricator ..... The lubricator supplies an oil mist to the Nailer.

Inspect the lubricator before operation to be sure the supply of lubricant is adequate.

Use Hitachi pneumatic tool lubricant.

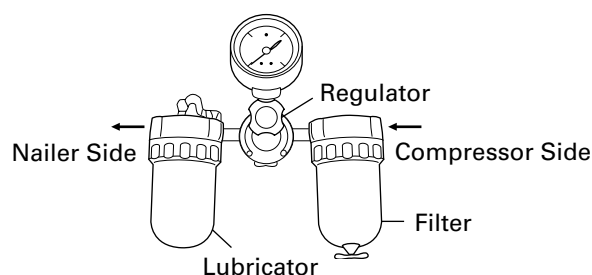

### 3. Air hose

Air hose must have a minimum working pressure rating of 150 psi (10.4 bar 10.6 kgf/cm<sup>2</sup>) or 150% of the maximum pressure produced in the system, whichever is higher.

### 4. Air consumption

Using the air consumption table and the air compressor size formula, find a correct compressor size.

Air consumption table

Operating pressure	psi (bar) (kgf/cm <sup>2</sup> )	80 (5.5) (5.6)	90 (6.2) (6.3)	100 (6.9) (7)
Air consumption	ft <sup>3</sup> /cycle (ltr/cycle)	.05 (1.4)	.056 (1.6)	.063 (1.8)

Air compressor size formula

Amount of air required

=number of Nailers

× average nails driven each minute per Nailer

× air consumption at given air pressure

× safety factor (always 1.2)

Example: 2 Nailers operating at 100 psi driving 30 nails per minute

Amount of air required

=2 × 30 × .063 (1.8) × 1.2

=4.5 CFM (ft<sup>3</sup>/min) (180 ltr/min)

After making the calculations as shown above, you should find a compressor providing 4.5 CFM of air that is required.

## LUBRICATION

It is important that the Nailer be properly lubricated.

Without proper lubrication, the Nailer will not work properly and parts will wear prematurely.

- Use Hitachi pneumatic tool lubricant.

Do not use detergent oil or additives. These lubricants will harm the O-rings and other rubber parts.

This will cause the Nailer to malfunction.

- Filter-regulator-lubricator units should always be used.

Keep the lubricator filled with Hitachi pneumatic tool lubricant.

- If a lubricator is not available, supply 5 – 10 drops of Hitachi pneumatic tool lubricant into the air plug on the Nailer twice a day.

## COLD WEATHER CARE

- Do not store the Nailer in a cold weather environment.

Keep the Nailer in a warm area until beginning the work.

- If the Nailer is already cold, bring it in a warm area and allow the Nailer to warm up before use.

(1) Reduce the air pressure to 64 psi (4.4 bar 4.5 kgf/cm<sup>2</sup>).

(2) Remove all nails from the Nailer.

(3) Connect the air hose and free-fire (blank-fire) the Nailer.

The lowered air pressure will be enough to free-fire the Nailer.

Slow speed operation tends to warm up the moving part.

## ⚠ CAUTION

- Do not free-fire the Nailer at high pressure.

## TRIGGER LOCK

When not in use, turn the lock lever to the lock position.

### ⚠ WARNING

- Turn the Lock Lever to the Lock Position when:

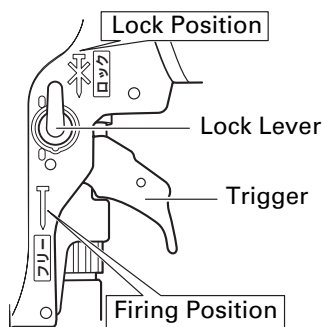

- 1) connecting air hose;
- 2) loading nails;
- 3) doing maintenance and inspection;
- 4) clearing a jam;
- 5) it is not in use;
- 6) leaving work area;
- 7) moving it to another location;
- 8) handing it to another person; and
- 9) using the hook.

## TESTING THE NAILER

### DANGER



- Always wear eye protector.

### WARNING

- Never use Nailer unless push lever is operating properly.

Before actually beginning the nailing work, test the Nailer by using the checklist below. Conduct the tests in the following order.

If abnormal operation occurs, stop using the Nailer and contact a Hitachi authorized service center immediately.

- (1) DISCONNECT AIR HOSE FROM NAILER.  
REMOVE ALL NAILS FROM NAILER.
  - ALL SCREWS MUST BE TIGHTENED.  
If any screws are loose, tighten them.
  - THE PUSH LEVER AND TRIGGER MUST MOVE SMOOTHLY.
- (2) Adjust the air pressure to 70 psi (4.9 bar 5 kgf/cm<sup>2</sup>).  
Connect the air hose.  
Do not load any nails in the Nailer.
  - THE NAILER MUST NOT LEAK AIR.  
Hold the Nailer downward and pull the trigger.
  - THE NAILER MUST NOT OPERATE.
- (3) With finger off the trigger, depress the push lever against the workpiece.
  - THE NAILER MUST NOT OPERATE.
- (4) Without touching the trigger, depress the push lever against the workpiece.  
Pull the trigger.
  - THE NAILER MUST OPERATE
- (5) With the Nailer off the workpiece, pull the trigger.  
Depress the push lever against the workpiece.
  - THE NAILER MUST OPERATE.
- (6) If no abnormal operation is observed, you may load nails in the Nailer.  
Drive nails into the workpiece that is the same type to be used in the actual application.
  - THE NAILER MUST OPERATE PROPERLY.

## ADJUSTING AIR PRESSURE

### WARNING

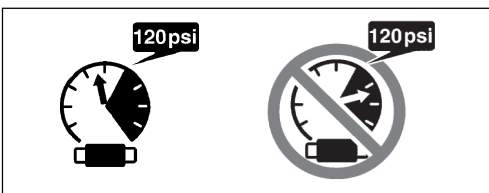

- Do not exceed 120 psi (8.3 bar 8.5 kgf/cm<sup>2</sup>).

Adjust the air pressure at recommended operating pressure 70 – 120 psi (4.9 – 8.3 bar 5 – 8.5 kgf/cm<sup>2</sup>) according to the length of nails and the hardness of workpiece.

The correct air pressure is the lowest pressure which will do the job. Using the Nailer at a higher than required air pressure unnecessarily over stresses the Nailer.

## LOADING NAILS

### WARNING

- When loading nails into nailer,
  - (1) do not depress trigger
  - (2) do not depress push lever; and
  - (3) keep Nailer pointed downward

**NOTE:**

Before loading nails in the magazine, adjust the plate. If the magazine cover is forcibly closed without adjusting the plate correctly, the nail holder may be damaged.

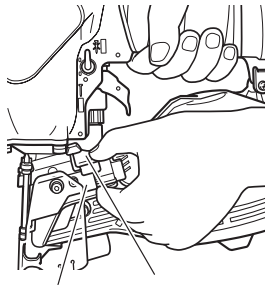

Nail guide Knob

- (1) Grip the nail guide and knob with finger. Press the knob down and swing the nail guide open. And open the magazine cover.

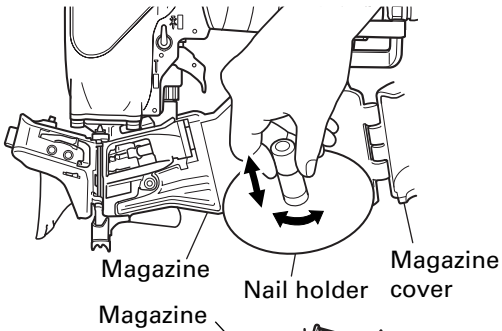

Magazine Nail holder Magazine cover

- (2) Adjust the position of the plate according to the nail length. The nail will not feed smoothly if the plate is not correctly adjusted.

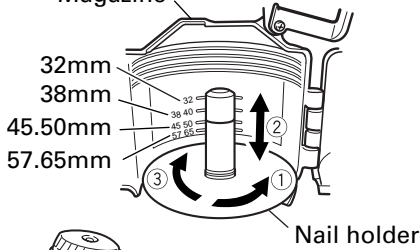

Magazine Nail holder

- ① Turn the nail holder about 90 degrees counterclockwise.
- ② Slide in vertical direction possible. Lift or lower the nail holder to accept different length nails.
- ③ Adjust the plate to the nail length reference points on the magazine cover and turn the nail holder 90 degrees clockwise until you hear "click".

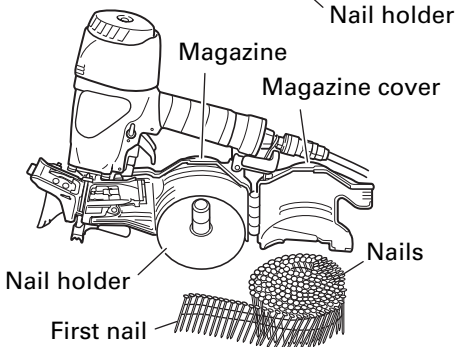

Magazine Magazine cover

Nail holder Nails First nail

- (3) Place the nail coil into the magazine. Uncoil enough nails to reach the driving hole.

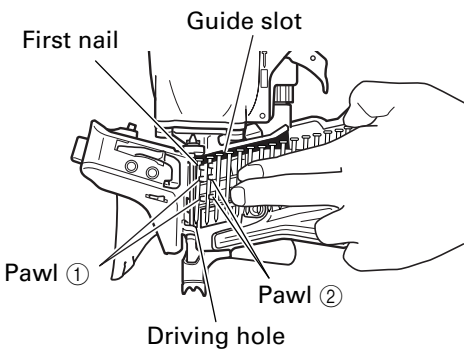

First nail Guide slot Pawl ① Pawl ② Driving hole First nail Guide slot

**Wire collated nails**

Insert the first nail into the driving hole and the second nail between the two pawls of the feeder. Fit the nail head in the guide slot.

**Plastic sheet collated nails**

Insert the first nail into the driving hole and the second nail between the two pawls of the feeder. Fit the nail head and upper side of the plastic sheet in the guide slot. Fit the lower side of the plastic sheet in the guide slot for plastic sheets.

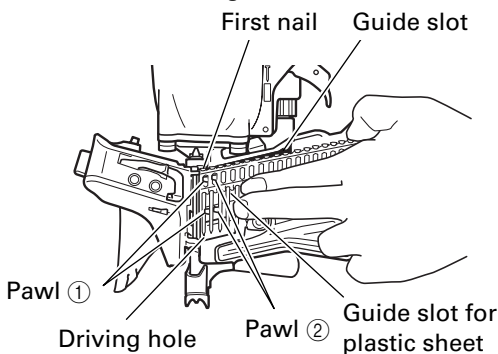

Pawl ① Driving hole Pawl ② Guide slot for plastic sheet

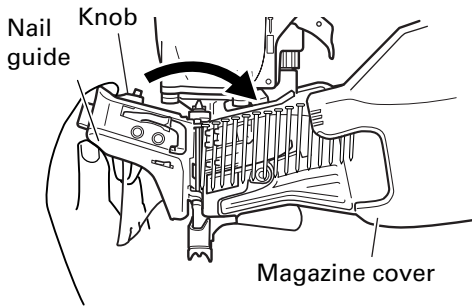

- (5) Close the magazine cover first and swing the nail guide closed.
- (6) Lock the knob correctly.

**NOTE:**

Be careful not to deform the collated wires and not to disengage the nails with the guide surface. Otherwise, the nail guide will not close correctly.

## **NAILER OPERATION**

Read section titled "SAFETY" (pages 4 - 6).

### **⚠ DANGER**

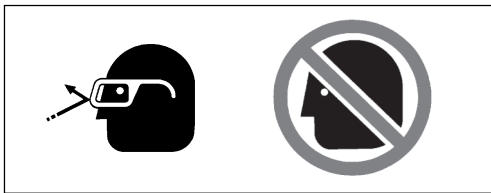

- Always wear eye protector with side shields which conforms to ANSI Z87.1 specifications.

### **⚠ WARNING**

- Never point Nailer toward yourself or anyone else.
- Never carry with finger on trigger.  
Remove finger from trigger when not driving nails.
- Never place your hands or feet closer than 8 inches (200 mm) from firing head when using.  
Do not drive nails on top of other nails or with Nailer at too steep of an angle; nails can ricochet and hurt someone.
- In order to avoid double fire or unwanted ejection of a nail due to bouncing of the Nailer.
  - 1) do not push Nailer on workpiece with strong force;
  - 2) take Nailer away from workpiece using recoil;
  - 3) release trigger quickly when performing trigger fire.
- Do not drive nails into thin boards or near corners and edges of workpiece. Nails can be driven through or away from workpiece and hit someone.
- Never drive nails from both sides of a wall at the same time. Nails can be driven into and through the wall and hit a person on the opposite side.
- Never use Nailer which is defective or operating abnormally.
- Do not use Nailer as hammer.
- Disconnect air hose from Nailer when:
  - 1) it is not in use;
  - 2) leaving work area;
  - 3) moving it to another location;
  - 4) handing it to another person; and
  - 5) using the hook.

## **METHODS OF OPERATION**

### **Lock lever**

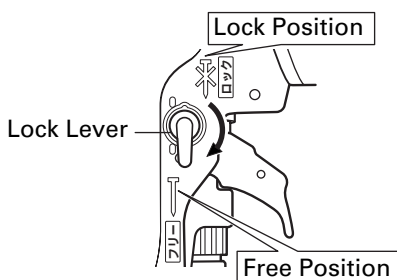

Turn the lock lever to the free position.

## Driving

This nailer is equipped with the push lever and dose not operate unless the push lever is depressed(upward position).

There are two methods of operation to drive nails with this nailer.

### (1) Single sequential actuation(Trigger fire)

## ⚠ WARNING

- **First nail is driven regardless of the contact action.**

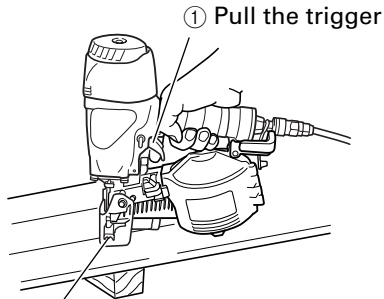

- Position the nail outlet on the workpiece with finger off the trigger.
- Depress the push lever firmly it is completely depressed.
- Pull the trigger to drive a nail.
- Remove finger from the trigger.

To drive another nail, move the Nailer along the workpiece and repeat this procedure.

### ② Depress the push lever

### (2) Contact action

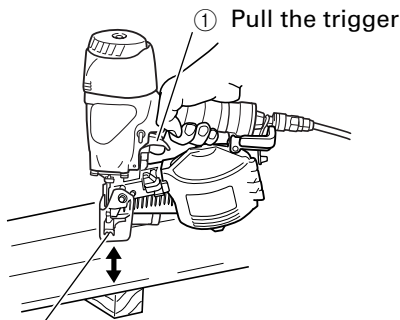

- Pull the trigger with the Nailer off the work piece.
  - Depress the push lever against the workpiece to drive a nail.
  - Move the Nailer along the workpiece with a bouncing motion. Each depression of the push lever will drive a nail.
- As soon as the desired number of nails have been driven, remove finger from the trigger.

### ② Depress the push lever

## ⚠ WARNING

- **Keep your finger off the trigger except during fastening operation, beacuse serious injury could result if the push lever accidentally contacts you or others in work area.**
- **Keep hands and body away from the discharge area. The nailer with contact trip mechanism may bounce from the recoil of driving a fastener and unwanted subsequent fastener may be driven, possibly causing injury.**
- **Some types of loaded nails can spark out of the muzzle during a nail driving operation. Exercise caution!**

## Nose cap

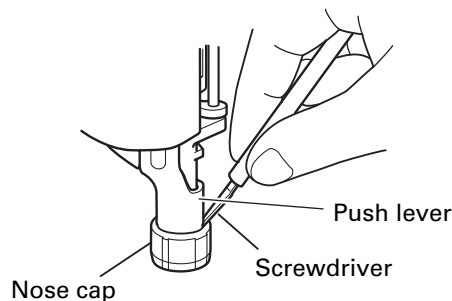
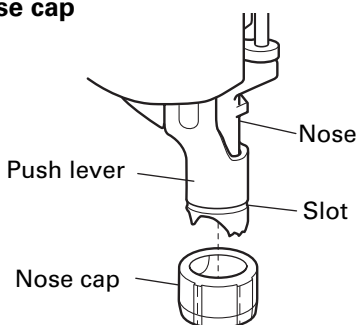

Put the nose cap accordingly. Pushing it into the top of push lever can put the nose cap. Nose cap can be removed from the push lever using a screwdriver or thin rod.

Nose cap can be stored on the magazine as shown below.

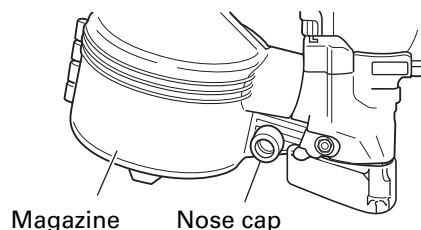

### Adjusting the nailing depth

To assure that each nail penetrate to the same depth, be sure that

- (1) the air pressure to the Nailer remains constant (regulator is installed and working properly)
- (2) the Nailer is always held firmly against the workpiece.

If nails are driven too deep or shallow into the workpiece, adjust the nailing depth in the following order.

- ① DISCONNECT AIR HOSE FROM NAILER
- ② If nails are driven too deep, turn the adjuster to the shallow side.  
If nails are driven too shallow, turn the adjuster to the deep side.

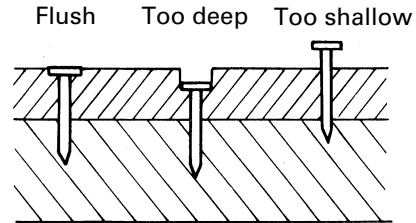
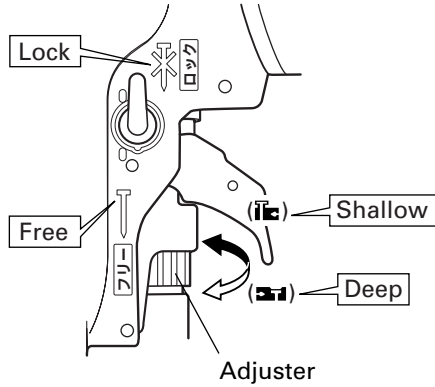

- ③ Stop turning the adjuster when a suitable position is reached for a nailing test.
- ④ Connect the air hose  
**ALWAYS WEAR EYE PROTECTOR.**  
Perform a nailing test.
- ⑤ DISCONNECT AIR HOSE FROM NAILER
- ⑥ Choose a suitable position for the nailer.

### Changing the exhaust direction

The direction of the exhaust vent can be changed by turning the head ring.

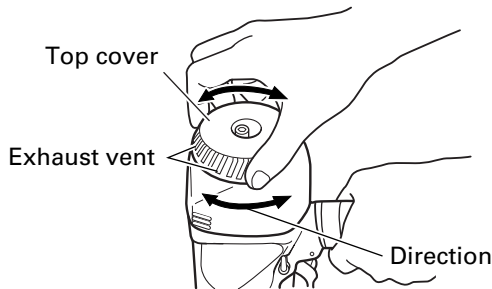

### Cutting off the sheet

Tear off the output sheet in the direction of the arrow when using the sheet collated nails.

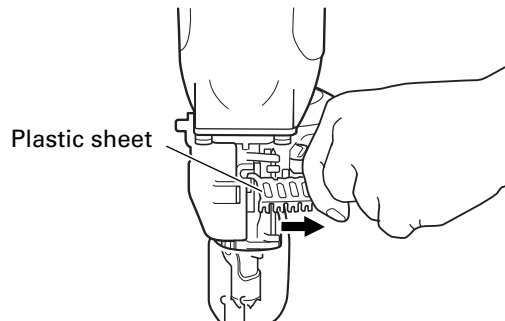

# MAINTENANCE

## NOTE:

The information contained in this Manual is designed to assist you in the safe maintenance of the Nailer. Some illustrations in this Manual may show details or attachments that differ from those on your own Nailer.

## MAINTENANCE AND INSPECTION

Read section titled "SAFETY" (page 4 – 6 ).

### ⚠ WARNING

- Disconnect air hose and remove all nails from Nailer when:
  - 1) doing maintenance and inspection; and
  - 2) clearing a jam.
- Never use gasoline or other highly flammable liquids for cleaning

#### 1. Clearing a jam

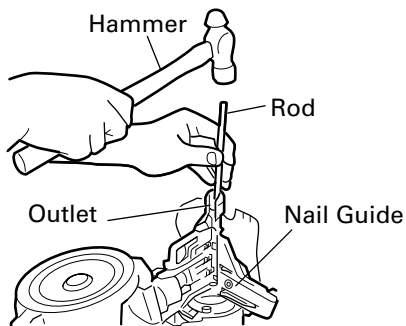

Remove a jammed nail in the following order:

- ① DISCONNECT AIR HOSE.
- ② Open the nail guide
- ③ Insert a rod into the outlet.  
Tap the rod with a hammer

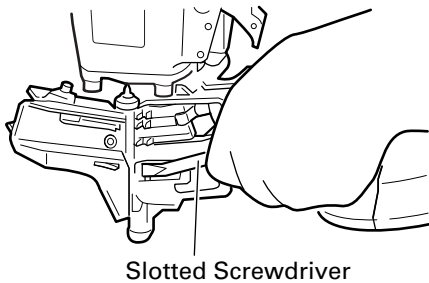

- ④ Remove the jammed nail with a slotted screwdriver

- ⑤ Cut the deformed collated wire/plastic sheet with nippers. Correct the deformation.
- ⑥ In case of frequent jam, contact a Hitachi authorized service center.

#### 2. Inspect the feeders

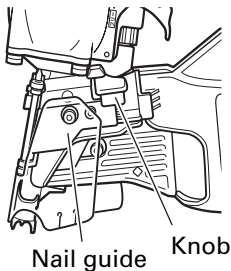

- ① DISCONNECT AIR HOSE.
- ② Clean the knob sliding part.  
Lubricate it with Hitachi pneumatic tool lubricant



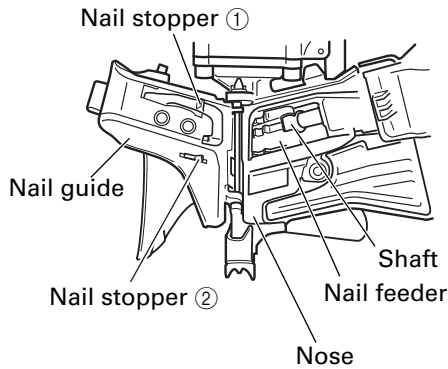

- ③ Open the nail guide and remove dust.  
Lubricate the sliding groove of the feeder and shafts.

### 3. Inspect the Trigger

Clean the trigger sliding part.  
Lubricate it with Hitachi pneumatic tool lubricant

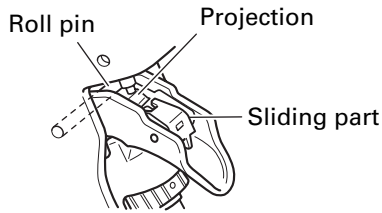

### 4. Inspect the muffler

In case dust choke up the muffler or muffler is damaged,  
Contact Hitachi for replacement.

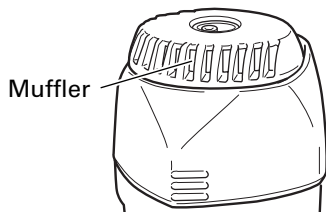

## ⚠ CAUTION

- Check that the nail feeder slides smoothly by pulling it with finger.  
If not smooth, nails can be driven at an irregular angle and hurt someone.

### 5. Inspecting Magazine

- ① DISCONNECT AIR HOSE
- ② Clean the magazine. Remove dust of wooden chips which may have accumulated in the magazine.

### 6. Storing

- When not in use for an extended period, apply a thin coat of the lubricant to the steel parts to avoid rust.
- Do not store the Nailer in a cold weather environment.  
Keep the Nailer in a warm area.
- When not in use, the Nailer should be stored in a warm and dry place.  
Keep out of reach children.

### 7. WARNING LABEL

Change the WARNING LABEL if missing or damaged.  
A new WARNING LABEL is available from a Hitachi authorized service center.

### 8. Maintenance chart (See page 21)

### 9. Operator troubleshooting (See page 21)

## SERVICE AND REPAIRS

### ⚠ WARNING

- Only service personnel trained by Hitachi, distributor or employer shall repair the Nailer.
- Use only parts supplied or recommended by Hitachi for repair.

All quality Nailers will eventually require servicing or replacement of parts because of wear from normal use.

### NOTE:

Specifications are subject to change without any obligation on the part of HITACHI.

## Maintenance chart

ACTION	WHY	HOW
Drain air line filter daily.	Prevent accumulation of moisture and dirt.	Open manual petcock.
Keep lubricator filled.	Keep the Nailer lubricated.	Fill with Hitachi pneumatic tool lubricant.
Clean filter element — then blow air through filter in direction opposite to normal flow.	Prevent clogging of filter with dirt.	Follow manufacturer's instructions.
Clean magazine and feeder mechanism.	Prevent a jam.	Blow clean daily.
Keep push lever working properly.	Promote operator safety and efficient Nailer operation.	Blow clean daily.
Lubricate the Nailer after nailing.	Extend the Nailer life.	Supply 5 – 10 drops of lubricant into the Nailer.
Drain air compressor.	Keep the Nailer operated properly.	Open petcock on air compressor tank.

## Operator troubleshooting

Most minor problems can be resolved quickly and easily using the table below.

If problems persist, contact a Hitachi authorized service center for assistance.

PROBLEM	CHECK METHOD	CORRECTION
Nailer operates, but no nail is driven.	Check for a jam.	Clear a jam.
	Check function of nail feeder per page 16.	Clean and lubricate.
	Ribbon spring weakened or damaged?	Replace ribbon spring.
	Check for proper nails.	Use only recommended nails.
Weak drive. Slow to cycle.	Check air pressure.	Increase air pressure. (Do not exceed 120 psi (8.3 bar 8.5 kgf/cm <sup>2</sup> ))
	---	Use Hitachi pneumatic tool lubricant.
	Driver blade worn?	Contact Hitachi for replacement.
	Piston O-ring worn or damaged?	
Drives too deep.	Check air pressure.	Reduce air pressure. (Adjust 70 – 120 psi)
Skipping nails. Intermittent feed.	Check for proper nails.	Use only recommended nails.
	Check function of nail feeder per page 16.	Clean and lubricate.
	Ribbon spring weakened or damaged?	Replace ribbon spring.
	---	Use Hitachi pneumatic tool lubricant.
	Piston O-ring cut or heavily worn?	Contact Hitachi for replacement.
Nails jam. Driven nail is bent.	Check for proper nails.	Use only recommended nails.
	Driver blade worn?	Contact Hitachi for replacement.
Drives properly during normal operation, but does not drive fully at faster nailing speeds.	Check inside diameter of air hose.	Use larger air hose

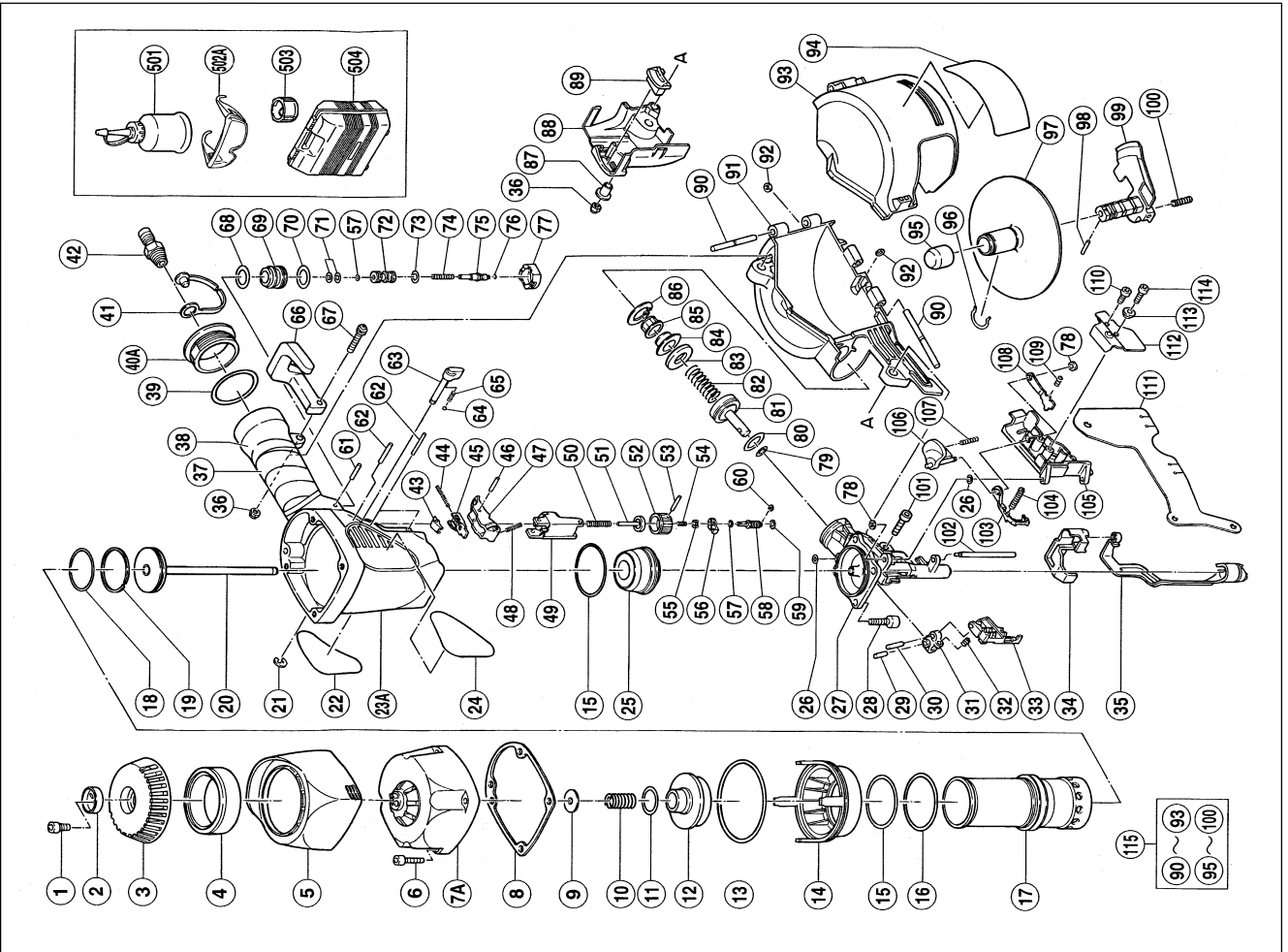

Item No.	Code No.	Part Name	Q'ty
1	949-657	Hex.Socket Hd. Bolt M6x12	1
2	882-919	Plate	1
3	882-917	Top Cover	1
4	882-918	Muffler	1
5	882-916	Protector(A)	1
6	949-662	Hex.Socket Hd. Bolt M5x25	4
7A	882-911	Exhaust Cover	1
8	882-915	Packing(A)	1
9	882-914	Head Bumper	1
10	882-913	Head Valve Spring	1
11	876-796	O-Ring(P-22)	1
12	882-912	Head Valve(A)	1
13	878-863	O-Ring(S-70)	1
14	882-910	Cylinder Plate	1
15	882-874	O-Ring(S-46)	2
16	877-368	O-Ring(P-48)	1
17	882-909	Cylinder	1
18	882-871	Piston O-Ring	1
19	882-872	Piston Ring	1
20	882-870	Piston	1
21	988-643	Retaining Ring for D4 Shaft	1
22	---	Name Plate	1
23A	882-908	Body Assy	1
24	---	Decor	1
25	882-873	Piston Bumper	1
26	874-436	O-Ring(P-4)	2
27	882-875	Nose	1
28	880-675	Hex.Socket Hd. Bolt M6x20	4
29	949-770	Roll Pin D4x14	1
30	880-659	Needle Roller	1
31	878-132	Feeder Arm	1
32	---	Feeder Spring	1
33	882-882	Feeder	1
34	882-900	Pushing Lever Cover(B)	1
35	882-884	Pushing Lever	1
36	877-371	Nylon Nut M5	2
37	881-768	Grip Taps(A)	1
38	880-407	Tape	2
39	880-183	O-Ring	1
40A	883-177	Cap	1
41	877-914	Dust Cap	1
42	874-782	Air Plug PT1/4	1
43	882-896	Trigger Piece	1
44	882-897	Spring	1
45	882-895	Trigger Arm(B)	1
46	881-951	Roll Pin D2.5x16	1
47	882-894	Trigger	1
48	882-898	Trigger Spring	1
49	882-885	Pushing Lever Guide	1
50	882-892	Pushing Lever Spring	1
51	882-891	Pushing Lever(C)	1
52	882-889	Adjuster	1
53	880-093	Roll Pin D2x16	1
54	882-890	Adjuster Spring	1
55	882-887	Adjuster Plate(B)	1
56	882-886	Adjuster Plate(A)	1
57	981-317	O-Ring(S-4)	2
58	882-888	Pushing Lever(B)	1
59	872-822	O-Ring(S-5)	1
60	872-971	Retaining Ring for D3 Shaft	1

Item No.	Code No.	Part Name	Q'ty
61	949-864	Roll Pin D3x22	1
62	949-865	Roll Pin D3x28	3
63	882-922	Lock Knob	1
64	959-148	Steel Ball	1
65	882-923	Lock Spring	1
66	881-827	Hook	1
67	880-881	Machinr Screw	1
68	877-699	Head Valve O-Ring	1
69	---	Valve Bushing(B)	1
70	878-885	O-Ring(S-18)	1
71	878-925	O-Ring	2
72	880-672	Valve Piston(B)	1
73	878-887	O-Ring	1
74	878-884	Plunger O-Ring	1
75	882-921	Plunger(A)	1
76	878-888	O-Ring	1
77	882-920	Valve Bushing(A)	1
78	880-319	Shft Ring	2
79	872-645	O-Ring(P-9)	1
80	880-330	O-Ring(P-21)	1
81	882-673	Feed Piston	1
82	882-883	Feed Spring	1
83	877-711	Dumper	1
84	880-331	Feed Piston Cover	1
85	878-305	Magazine Bushing	1
86	939-555	Retaining Ring for D28 Hole	1
87	882-907	Sleeve	1
88	882-899	Pushing Lever Cover(A)	1
89	882-901	Protector(B)	1
90	881-825	Pin	2
91	882-903	Magazine	1
92	877-826	Feeder Shaft Ring	2
93	882-904	Magazine Cover	1
94	---	Label	1
95	881-003	Holder Cap(A)	1
96	880-398	Ratchet Spring	1
97	882-906	Nail Holder	1
98	878-791	Roll Pin D2.5x12	1
99	882-905	Holder Shaft	1
100	881-826	Spring	1
101	949-757	Hex.Socket Hd. Bolt M5x20	1
102	880-658	Nail Guide Shaft	1
103	882-877	Nail Stopper(A)	1
104	882-878	Nail Stopper Spring	1
105	882-876	Nail Guide	1
106	880-318	Guide Lock	1
107	880-446	Spring	1
108	882-680	Nail Stopper(B)	1
109	880-494	Stopper Spring	1
110	880-413	Hex.Socket Hd. Bolt M4x10	1
111	882-880	Cover	1
112	882-879	Nail Guide Cover	1
113	882-881	Sleeve(B)	1
114	880-630	Hex.Socket Hd. Bolt M4x12	1
115	882-902	Magazine Assy	1
501	877-163	Oiler	1
502A	875-769	Eye Protector	1
503	880-678	Nose Cap(A)	1
504	880-517	Case	1

Parts are subject to change without any obligation on the part of the HITACHI due to improvements.

# **Hitachi Koki Co., Ltd.**

Shinagawa Intercity Tower A, 15-1, Konan 2-chome,  
Minato-ku, Tokyo 108-6020, Japan