

Trimmer and Brushcutter Safety Manual

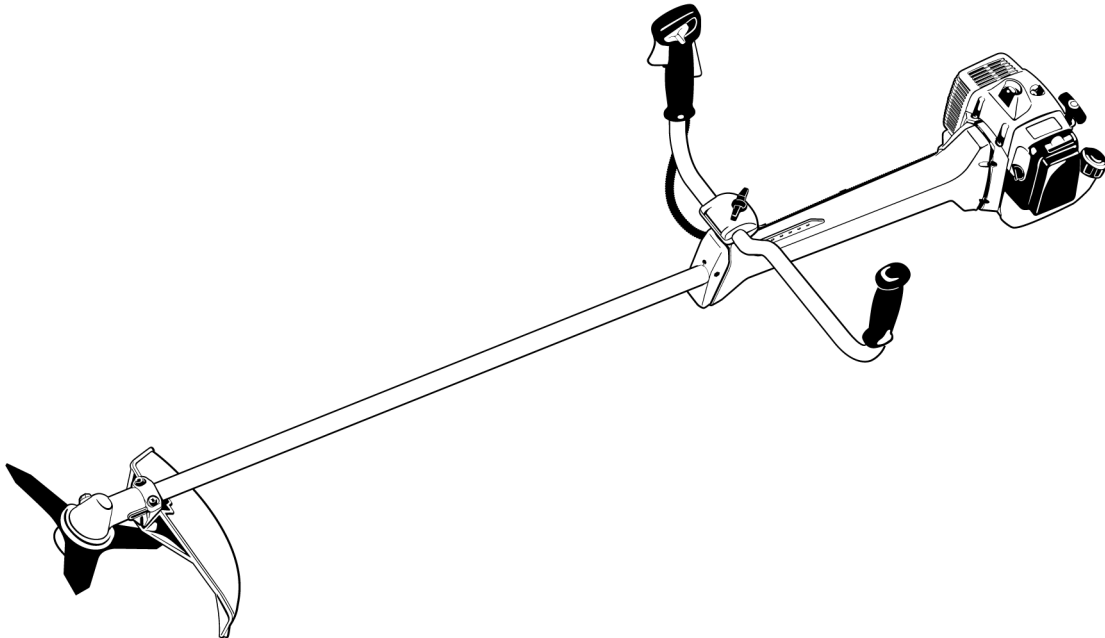

Contents

Safety Precautions and Working Techniques	2
Maintenance and Care	11
Main Parts	13

This manual contains the safety precautions and recommended working techniques outlined in the instruction manuals for STIHL trimmers and brushcutters.

The chapter on "Main Parts and Controls" shows the FS 130 as an example. Other trimmers and brushcutters may have different parts and controls.

This manual contains references to various chapters in the model-specific instruction manuals.

You should therefore always refer to the instruction manual of your particular trimmer or brushcutter model.

The approved combinations of cutting attachment, deflector, handle and harness are particularly important. Use only the combinations approved in the model-specific instruction manual.

Please contact your STIHL dealer if you have any questions after reading this manual.



Safety Precautions and Working Techniques



Some special safety precautions must be observed to reduce the risk of personal injury when operating this power tool because of the very high speed of its cutting attachment.



It is important you read and understand the instruction manual before using your unit for the first time and keep the manual in a safe place for future reference. Non-observance of the safety precautions may result in serious or even fatal injury.

Observe all applicable local safety regulations, standards and ordinances.

If you have not used this type of power tool before: Have your dealer or other experienced user show you how to operate your power tool or attend a special course in its operation.

Minors should never be allowed to use a power tool.

Keep bystanders, especially children, and animals away from the work area.

When the power tool is not in use, shut it off so that it does not endanger others. Secure it against unauthorized use.

The user is responsible for avoiding injury to third parties or damage to their property.

Do not lend or rent your power tool without the instruction manual. Be sure that anyone using it understands the information contained in this manual.

The use of noise emitting power tools may be restricted to certain times by national or local regulations.

To operate the power tool you must be rested, in good physical condition and mental health.

If you have any condition that might be aggravated by strenuous work, check with your doctor before operating a power tool.

Persons with pacemakers only: The ignition system of your power tool produces an electromagnetic field of a very low intensity. This field may interfere with some pacemakers. To reduce health risks, STIHL recommends that persons with pacemakers consult their physician and the pacemaker manufacturer before operating this tool.

Do not operate the power tool if you are under the influence of any substance (drugs, alcohol) which might impair vision, dexterity or judgment.

Depending on the cutting attachment fitted, use your brushcutter only for cutting grass, wild growth, shrubs, scrub, bushes, small diameter trees and similar materials.

It must not be used for any other purpose because of the increased risk of accidents and damage to the machine. Never attempt to modify your power tool in any way since this may result in accidents or damage to the machine.

Only use cutting attachments and accessories that are explicitly approved for this power tool model by STIHL or are technically identical. If you have any questions in this respect, consult a servicing dealer. Use only high quality parts and accessories in order to avoid the risk of accidents and damage to the machine.

STIHL recommends the use of genuine STIHL replacement parts. They are specifically designed to match your model and meet your performance requirements.

Never attempt to modify your power tool in any way since this may increase the risk of personal injury. STIHL excludes all liability for personal injury and damage to property caused while using unauthorized attachments.

Do not use a pressure washer to clean the unit. The solid jet of water may damage parts of the unit.

The deflector on this power tool cannot protect the operator from all objects thrown by the cutting attachment (stones, glass, wire, etc.). Such objects may ricochet and then hit the operator.

Clothing and Equipment

Wear proper protective clothing and equipment.



Clothing must be sturdy but allow complete freedom of movement. Wear snug-fitting clothing, an overall and jacket combination, do not wear a work coat.

Avoid clothing that could get caught on branches or brush or moving parts of the machine. Do not wear a scarf, necktie or jewelry. Tie up and confine long hair (e.g. with a hair net, cap, hard hat, etc.).



Wear steel-toed safety boots with non-slip soles.

Sturdy shoes with non-slip soles may be worn as an alternative only when using mowing heads.



Wear a safety hard hat for thinning operations, when working in high scrub and where there is a danger of head injuries from falling objects. To reduce the risk of injury from thrown objects, always wear a face shield and safety glasses.

A face shield alone does not provide adequate eye protection.

Wear hearing protection, e.g. earplugs or ear muffs.



Wear heavy-duty gloves.

STIHL offers a comprehensive range of personal protective clothing and equipment.

Transporting the Power Tool

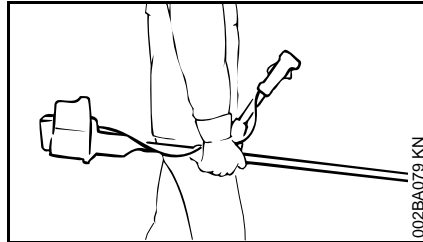
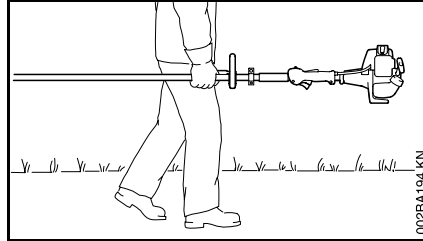

Always turn off the engine.

Carry the unit hanging from the shoulder strap or properly balanced by the drive tube. Fit transport guard on metal cutting attachments to avoid the risk of injury from blade contact

Transporting in a vehicle: Properly secure your power tool to prevent turnover, fuel spillage and damage.

Fueling



Gasoline is an extremely flammable fuel. Keep clear of naked flames. Do not spill any fuel – do not smoke.

Always shut off the engine before refueling.

Do not fuel a hot engine – fuel may spill and cause a fire.

Open the fuel cap carefully to allow any pressure build-up in the tank to release slowly and avoid fuel spillage.

Fuel your power tool only in well-ventilated areas. If you spill fuel, wipe the machine immediately – if fuel gets on your clothing, change immediately.

Your power tool comes standard with either a screw-type or bayonet-type fuel cap.



After fueling, tighten down the screw-type fuel cap as securely as possible.



Insert the fuel cap with hinged grip (bayonet-type cap) correctly in the opening, turn it clockwise as far as stop and fold the grip down.

This reduces the risk of unit vibrations causing the fuel cap to loosen or come off and spill quantities of fuel.

To reduce the **risk of serious or fatal burn injuries**, check for fuel leakage. If fuel leakage is found, do not start or run the engine until leak is fixed.

Before Starting

Check that your power tool is properly assembled and in good condition – refer to appropriate chapters in the instruction manual.

- Use only an approved combination of cutting attachment, deflector, handle and harness. All parts must be assembled properly and securely.
- Slide control / stop switch must move easily to **STOP** or **0**
- Smooth action of throttle trigger interlock (if fitted) and throttle trigger – the throttle trigger must return automatically to the idle position.
- Check that the spark plug boot is secure – a loose boot may cause arcing that could ignite combustible fumes and cause a fire.
- Cutting tool or attachment: Check for correct and secure assembly and good condition.
- Check protective devices (e.g. deflector for cutting tool, rider plate) for damage or wear. Always replace damaged parts. Do not operate your machine with a damaged deflector or worn rider plate (lettering and arrows no longer legible).
- Never attempt to modify the controls or the safety devices in any way.
- Keep the handles dry and clean – free from oil and dirt – for safe control of the power tool.
- Adjust the harness and handle(s) to suit your height and reach. See chapters on "Fitting the Harness" and "Balancing the Trimmer/Brushcutter".

To reduce the risk of personal injury, do not operate your power tool if it is damaged or not properly assembled.

If you use a shoulder strap or full harness: Practise removing and putting down the machine as you would in an emergency. To avoid damage, do not throw the machine to the ground when practising.

Starting the Engine

Start the engine at least 3 meters from the fueling spot, outdoors only.

Place the unit on firm ground in an open area. Make sure you have good balance and secure footing. Hold the unit securely. The cutting attachment must be clear of the ground and all other obstructions because it may begin to run when the engine starts.

Your brushcutter is a one-person unit. **To reduce the risk of injury** from thrown objects, do not allow other persons within a radius of 15 meters of your own position – even when starting.



To reduce the risk of injury, avoid contact with the cutting attachment.



Do not drop start the power tool – start the engine as described in the instruction manual. Note that the cutting attachment continues to run for a short period after you let go of the throttle trigger – **fly-wheel effect.**

Check idle speed setting: The cutting attachment must not rotate when the engine is idling with the throttle trigger released.

To reduce the risk of fire, keep hot exhaust gases and hot muffler away from easily combustible materials (e.g. wood chips, bark, dry grass, fuel).

Holding and Controlling the Unit

Always hold the unit firmly with both hands on the handles.

Make sure you always have good balance and secure footing.

Models with bike handle

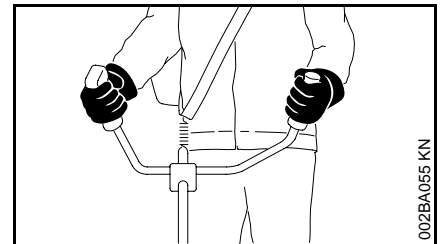

Right handle on control handle, left hand on left handle.

Models with loop handle

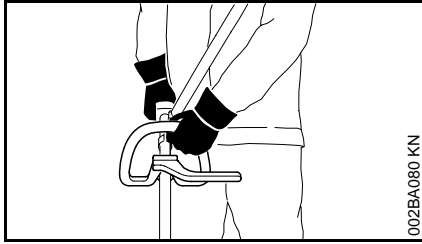

On units with a loop handle and barrier bar, left hand on loop handle, right hand on control handle, even if you are left-handed.

During Operation

In the event of impending danger or in an emergency, switch off the engine immediately by moving the slide control / stop switch to **STOP** or **0**.

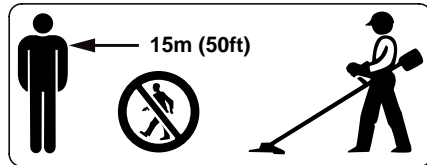

To reduce the risk of personal injury, do not allow any other persons within a radius of 15 meters of your own position. To reduce the risk of damage to property, also maintain this distance from other objects (vehicles, windows).

The correct engine idle speed is important to ensure that the cutting attachment stops rotating when you let go of the throttle trigger.

Check and correct the idle speed setting at regular intervals. If the cutting attachment still rotates at idle speed, have your dealer make proper adjustments or repairs.

Take special care in slippery conditions – damp, snow, ice, on slopes or uneven ground.

Watch out for obstacles: Roots, tree stumps or holes which could cause you to trip or stumble.

Make sure you always have good balance and secure footing.

Always stand on the ground while working, never on a ladder, work platform or any other insecure support.

Be particularly alert and cautious when wearing hearing protection because your ability to hear warnings (shouts, alarms, etc.) is restricted.

To reduce the risk of accidents, take a break in good time to avoid tiredness or exhaustion.

Work calmly and carefully – in daylight conditions and only when visibility is good. Stay alert so as not to endanger others.



Your power tool produces toxic exhaust fumes as soon as the engine is running. These fumes may be colorless and odorless and contain unburned hydrocarbons and benzol. Never run the engine indoors or in poorly ventilated locations, even if your model is equipped with a catalytic converter.

To reduce the risk of serious or fatal injury from breathing toxic fumes, ensure proper ventilation when working in trenches, hollows or other confined locations.

To reduce the risk of accidents, stop work immediately in the event of nausea, headache, visual disturbances (e.g. reduced field of vision), problems with hearing, dizziness, deterioration in ability to concentrate. Apart from other possibilities, these symptoms may be caused by an excessively high concentration of exhaust gases in the work area.

Operate your power tool so that it produces a minimum of noise and emissions – do not run the engine unnecessarily, accelerate the engine only for cutting.

To reduce the risk of fire, do not smoke while operating or standing near your power tool. Note that combustible fuel vapor may escape from the fuel system.

The dusts, vapor and smoke produced during operation may be dangerous to health. If the work area is very dusty or smoky, wear a respirator.

If your power tool is subjected to unusually high loads for which it was not designed (e.g. heavy impact or a fall), always check that it is in good condition before continuing work – see also "Before Starting".

Check the fuel system in particular for leaks and make sure the safety devices are working properly. Do not continue operating your power tool if it is

damaged. In case of doubt, have the machine checked by your servicing dealer.

Do not operate your power tool with the starting throttle lock engaged – engine speed cannot be controlled in this position.



To reduce the risk of injury from thrown objects, never operate the unit without the proper deflector for the type of cutting attachment being used.



Check the work area: Stones, pieces of metal or other solid objects can be thrown and cause personal injury or damage the cutting attachment and property (e.g. parked vehicles, windows).

Special care must be taken when working in difficult, over-grown terrain.

When cutting high scrub, under bushes and hedges: Keep cutting tool at minimum height of 15 cm to avoid harming small animals.

Before leaving the power tool unattended: Shut off the engine.

Check the cutting attachment at regular short intervals during operation or immediately if there is a noticeable change in cutting behavior:

- Turn off the engine. Hold brushcutter firmly and wait for the cutting attachment to come to a standstill.
- Check condition and tightness, look for cracks.
- Check sharpness.
- Replace damaged or dull cutting attachments immediately.

Clean grass and plant residue off the cutting attachment mounting at regular intervals – remove any build up of material from the cutting attachment and deflector.

To **reduce the risk of injury**, shut off the engine before replacing the cutting attachment.

Do not continue using or attempt to repair damaged or cracked cutting attachments by welding, straightening or modifying the shape (out of balance).

This may cause parts of the cutting attachment to come off and hit the operator or bystanders at high speed and **result in serious or fatal injuries**.

When using mowing heads

Equip the deflector with the additional components specified in the instruction manual.

Use only the deflector with properly mounted line limiting blade to ensure the mowing lines are automatically trimmed to the approved length.

To **reduce the risk of injury**, always turn off the engine before adjusting the nylon line of manually adjustable mowing heads

Using the unit with over-long nylon cutting lines reduces the motor's operating speed. The clutch then slips continuously and this causes overheating and damage to important components (e.g. clutch, polymer housing components) – and this can increase the risk of injury from the cutting attachment rotating while the engine is idling.

When using metal cutting tools

STIHL recommends the use of original STIHL metal cutting attachments. They are specifically designed to match your model and meet your performance requirements.

Metal cutting attachments rotate at very high speed. The forces that occur act on the machine, the attachment and the material being cut.

Sharpen metal cutting attachments regularly as specified.

Unevenly sharpened metal cutting attachments cause out-of-balance which can impose extremely high loads on the machine and increase the **risk of breakage**.

Dull or improperly sharpened cutting edges can put a higher load on the cutting attachment and increase the **risk of injury** from cracked or broken parts.

Inspect metal cutting attachments for cracks or warping after every contact with hard objects (e.g. stones, rocks, pieces of metal). To **reduce the risk of injury**, remove burrs and other visible build-ups of material (use a file) because they may become detached and be thrown at high speed during operation.

To reduce the above-mentioned risks when using a metal cutting attachment, never use a metal cutting attachment with a diameter larger than specified. It must not be too heavy. It must be manufactured from materials of adequate quality and its geometry must be correct (shape, thickness).

To **reduce the risk of injury**, a metal cutting attachment not manufactured by STIHL must not be heavier, thicker, have a different shape or a diameter larger than the largest metal cutting attachment approved by STIHL for this power tool model.

Vibrations

Prolonged use of the power tool may result in vibration-induced circulation problems in the hands ("white finger disease").

No general recommendation can be given for the length of usage because it depends on several factors.

The period of usage is prolonged by:

- Hand protection (wearing warm gloves)
- Work breaks

The period of usage is shortened by:

- Any personal tendency to suffer from poor circulation (symptoms: frequently cold fingers, tingling sensation)
- Low outside temperatures
- Amount of gripping force (holding the power tool tightly restricts circulation)

Users who use the machine periodically or for long periods or users who repeatedly experience corresponding symptoms (e.g., tingling sensation in fingers), should undergo a medical examination.

Maintenance and Repairs

Service the machine regularly. Do not attempt any maintenance or repair work not described in the instruction manual. Have all other work performed by a servicing dealer.

STIHL recommends that you have servicing and repair work carried out exclusively by an authorized STIHL servicing dealer. STIHL dealers are regularly given the opportunity to attend training courses and are supplied with the necessary technical information.

Only use high-quality replacement parts in order to avoid the risk of accidents and damage to the machine. If you have any questions in this respect, consult a servicing dealer.

STIHL recommends the use of genuine STIHL replacement parts. They are specifically designed to match your model and meet your performance requirements.

To reduce the risk of injury, **always shut off the engine** before carrying out any maintenance or repairs or cleaning the machine. – Exception: Carburetor and idle speed adjustments.

Do not turn the engine over on the starter with the spark plug boot or spark plug removed unless the slide control /

stop switch is on **STOP** or **0** since there is otherwise a **risk of fire** from uncontained sparking.

To reduce the **risk of fire**, do not service or store your machine near open flames.

Check the fuel filler cap for leaks at regular intervals.

Use only a spark plug of the type approved by STIHL and make sure it is in good condition – see "Specifications".

Inspect the ignition lead (insulation in good condition, secure connection).

Check the condition of the muffler.

To reduce the **risk of fire and damage to hearing**, do not operate your machine if the muffler is damaged or missing.

Do not touch a hot muffler since **burn injury** will result.

Vibration behavior is influenced by the condition of the AV elements – check the AV elements at regular intervals.

Symbols on Deflectors

An **arrow** on the deflector shows the correct direction of rotation of the cutting attachments.

Some of the following symbols are applied to the outside of the deflector to indicate the approved combination of cutting attachment and deflector.



Deflector may be used with mowing heads.



Deflector may be used with grass cutting blades.



Deflector must not be used with mowing heads.



Do not use deflector with brush knives, shredder blades or circular saw blades.



Do not use deflector with brush knives, shredder blades, grass cutting blades or circular saw blades.



Deflector may be used with mowing heads. Not approved for use with brush knives, shredder blades or circular saw blades.



Deflector may be used with mowing heads – do not use metal cutting attachments.

Shoulder strap / Harness

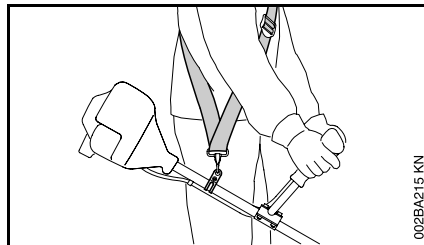

- Use a harness conforming to the approved combinations of cutting attachment, deflector, handle and harness in the model-specific instruction manual.
- With the engine running, attach the machine to the harness.

The following applies within the European Union (EU):

Grass cutting blades, brush knives and shredder blades must always be used in combination with a shoulder strap or full harness.

Circular saw blades must always be used in combination with a full harness with a quick-action release system.

Mowing Head with Nylon Lines

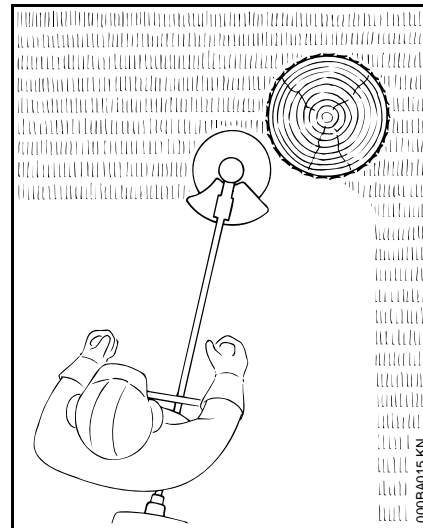

For trimming around fence posts, trees, etc. – less risk of damaging tree bark.

⚠ To reduce the **risk of injury**, **never** use steel wire in place of the nylon cutting line.

STIHL Polycut Mowing Head with Polymer Blades

For mowing unobstructed edges of meadows (without posts, fences, trees or similar obstacles).

Check the wear limit marks!

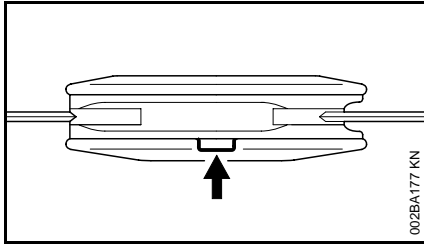

If one of the wear limit marks on the PolyCut mowing head is worn through (arrow): Do not continue using the mowing head. Install a new one. There is otherwise a **risk of injury** from thrown parts of the head.

It is important to follow the maintenance instructions for the Polycut mowing head.

Risk of Kickout (Blade Thrust) with Metal Cutting Attachments

When using metal cutting attachments (grass cutting blade, brush knife, shredder blade, circular saw blade) there is a risk of kickout when the rotating blade comes into contact with a solid object such as a tree trunk, branch, tree stump, rock or similar. The machine is thrown to the right or to the rear – opposite to the attachment's direction of rotation.

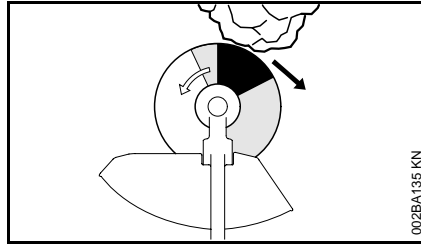

The **risk of kickout is greatest** when the **black area** of the rotating cutting attachment comes into contact with a solid object.

Grass Cutting Blade

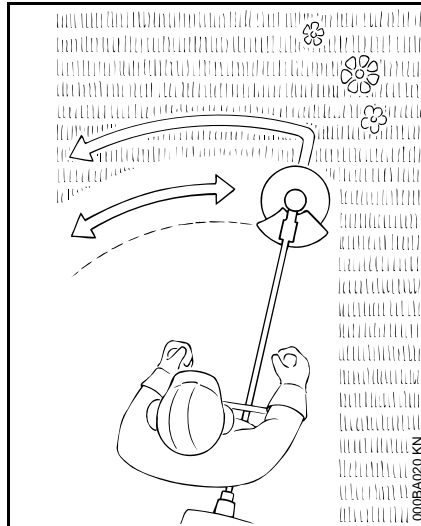

Use for grass and weeds only – sweep the brushcutter in an arc like a scythe.

! Improper use may damage the grass cutting blade – **risk of injury** from thrown parts.

Resharpener the grass cutting blade according to instructions when it has dulled noticeably.

Brush Knife

Suitable for cutting matted grass, wild growth and scrub, thinning young stands with a maximum stem diameter of 2 cm. To **reduce the risk of personal injury**, never attempt to cut thicker wood.

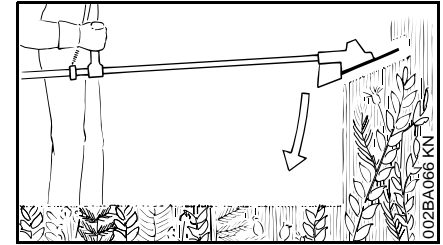

To cut wild growth and scrub, lower the brush knife down onto the growth to achieve shredding effect – do not use the cutting attachment above waist height.

Exercise extreme caution when using this method of cutting. The higher the cutting attachment is off the ground, the greater the risk of injury from cuttings being thrown sideways.

Use the brushcutter like a scythe (sweep it to the right and left) at ground level when cutting grass and thinning young stands.

Warning! Improper use of a brush knife may cause it to crack, chip or shatter – **risk of injury** from thrown parts.

To reduce the risk of injury it is essential to take the following precautions

- Avoid contact with stones, rocks, pieces of metal and other solid foreign objects.
- Never cut wood or shrubs with a stem diameter of more than 2 cm – use a circular saw blade for this purpose.
- Inspect the brush knife at regular short intervals for signs of damage. Do not continue working with a damaged brush knife.
- Resharpener the brush knife regularly (when it has dulled noticeably) and have it balanced if necessary (STIHL recommends a STIHL servicing dealer).

Shredder Blade

Suitable for thinning and shredding tough, matted grass and scrub.

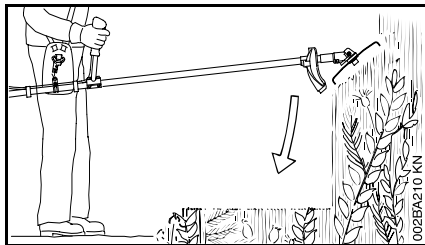

To cut wild growth and scrub, lower the shredder blade down onto the growth to achieve shredding effect – do not use the cutting attachment above waist height.

Exercise extreme caution when using this method of cutting. The higher the cutting attachment is off the ground, the greater the risk of injury from cuttings being thrown sideways.

Warning! Improper use may damage the shredder blade – **risk of injury** from thrown parts.

To reduce the risk of injury it is essential to take the following precautions:

- Avoid contact with stones, rocks, pieces of metal and other solid foreign objects.
- Never cut wood or shrubs with a stem diameter of more than 2 cm.
- Inspect the shredder blade at regular short intervals for signs of damage. Do not continue working with a damaged shredder blade.
- Resharpener the shredder blade when it has dulled noticeably and have it balanced if necessary (by servicing dealer).

Circular Saw Blade

For cutting shrubs and trees:

Up to a stem diameter of 4 cm when used on brushcutters.

Up to a stem diameter of 7 cm when used on clearing saws.

Before starting the cut, accelerate the engine up to full throttle. Perform cut with uniform pressure.

Use circular saw blades only with a matching limit stop of the correct diameter.

 To reduce the risk of blade damage, avoid contact with stones and the ground. Resharpener the blade properly in good time – dull teeth may result in the blade cracking and shattering and causing serious injury.

When felling, maintain a distance of at least two tree lengths from the next felling site.

Risk of kickout

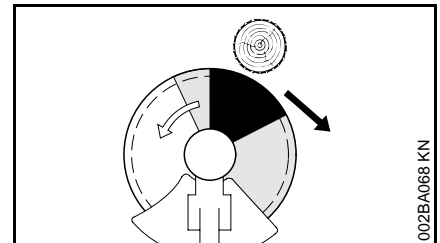

The risk of kickout is highest in the black area of the blade: Do not use this area of the circular saw blade for cutting.

There is also a risk of kickout when using the lighter shaded areas of the blade: These areas of the blade should only be used by experienced operators with specialized training.

STIHL recommends that you use the non-shaded area of the circular saw blade. Always start the cut with this area of the blade.

Maintenance and Care

The following intervals apply to normal operating conditions only. If your daily working time is longer or operating conditions are difficult (very dusty work area, etc.), shorten the specified intervals accordingly.		before starting work	after finishing work or daily	after each refueling stop	weekly	monthly	every 12 months	if problem	if damaged	if required
Complete machine	Visual inspection (condition, leaks)	X		X						
	Clean		X							
Control handle (top handle)	Check operation	X		X						
Air filter	Clean							X		X
	Replace								X	
Pickup body in fuel tank	Check							X		
	Replace					X			X	X
Fuel tank	Clean					X		X		X
Carburetor	Check idle adjustment – the cutting attachment must not turn	X		X						
	Readjust idle									X
Spark plug	Readjust electrode gap							X		
	Replace after every 100 operating hours									
Cooling inlets	Visual inspection		X							
	Clean									X
Spark arresting screen ¹⁾ in muffler	Check ²⁾							X		X
	Clean or replace ²⁾								X	
All accessible screws and nuts (not adjusting screws)	Retighten									X
Antivibration elements	Check	X						X		X
	Replace ²⁾								X	
Cutting attachment	Visual inspection	X		X						
	Replace								X	
	Check tightness	X		X						

The following intervals apply to normal operating conditions only. If your daily working time is longer or operating conditions are difficult (very dusty work area, etc.), shorten the specified intervals accordingly.		before starting work	after finishing work or daily	after each refueling stop	weekly	monthly	every 12 months	if problem	if damaged	if required
Metal cutting attachment	Sharpen	X								X
Gearbox lubrication	Check				X			X		X
	Replenish									X
Safety labels	Replace								X	

1) not in all versions, market-specific

2) STIHL recommends that this work be done by a STIHL servicing dealer

Main Parts

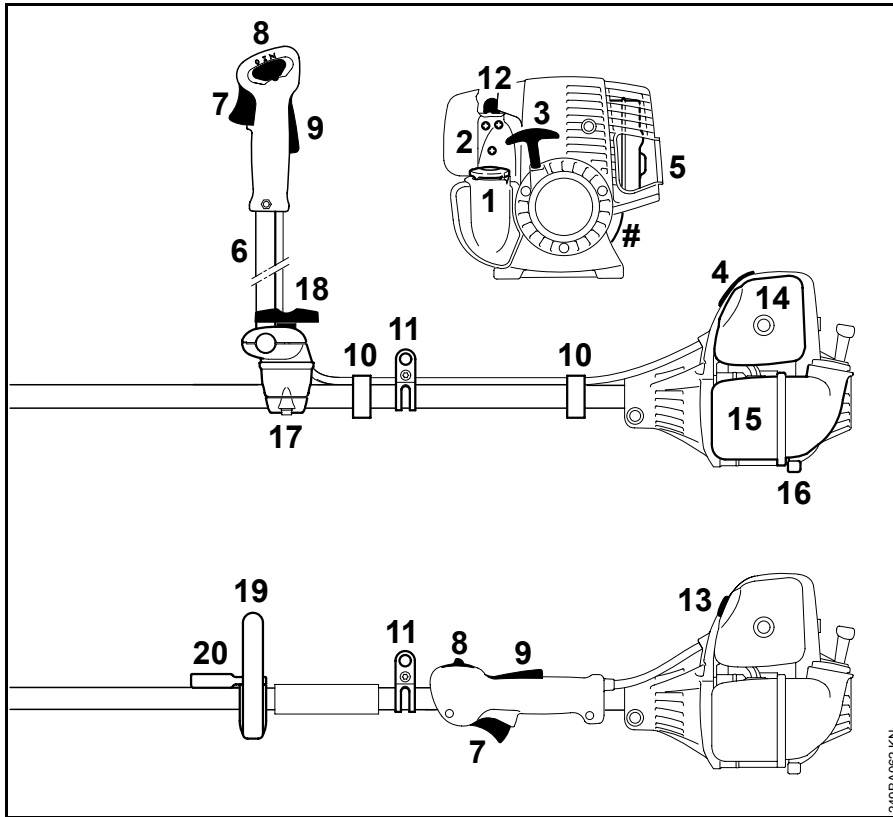

- 1 Fuel filler cap
- 2 Carburetor adjusting screws
- 3 Starter grip
- 4 Spark plug boot
- 5 Muffler (with spark arrestor in some markets)
- 6 Bike handle (handlebar)
- 7 Throttle trigger
- 8 Slide control
- 9 Throttle trigger interlock
- 10 Throttle cable retainer
- 11 Carrying ring
- 12 Fuel pump
- 13 Choke knob
- 14 Air filter cover
- 15 Fuel tank
- 16 Machine support
- 17 Handle support
- 18 Wing screw
- 19 Loop handle
- 20 Barrier bar (country specific)
- # Serial number

249BA062 KN

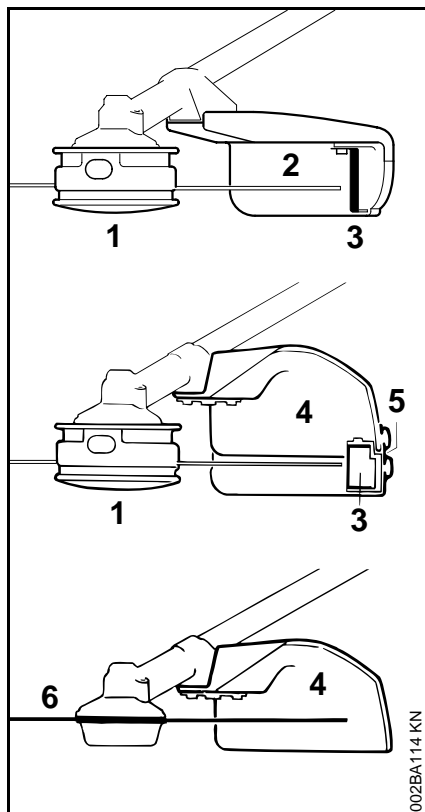

- 1 Mowing head
- 2 Deflector for mowing heads only
- 3 Blade
- 4 Deflector for all mowing attachments
- 5 Skirt
- 6 Metal mowing attachment

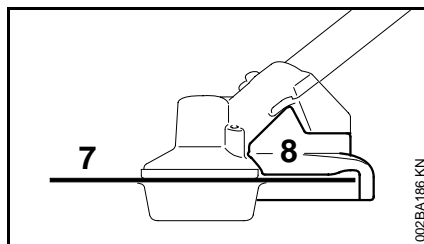

- 7 Circular saw blade
- 8 Limit stop for circular saw blades only

0457-187-0121

englisch



www.stihl.com