

INSTRUCTION MANUAL

DENYO

DIESEL GENERATING SETS

Before using, be sure to read this manual for the sake of safety.

Be sure to observe the items under symbol marks "⚠ WARNING"
and "⚠ CAUTION" for the sake of safety.

Always keep this manual at your machine for the sake of safety.

DCA-45SPI

DCA-60SPI

DCA-75SPI

 **Denyo Co., Ltd.**

2-8-5 Nihonbashi-horidomecho, Chuo-ku, Tokyo, 103-8566 Japan

FOREWORD

- * Your machine is a portable type diesel generating set.
(Specifications: See p.68)
- * Do not install, operate or repair this machine without reading this operating manual.
- * This generator set (machine) must be operated by a person having sufficient knowledge and skill for the sake of safety.

Notes on instruction manual

- * This instruction manual explains correct operation and maintenance of the machine to ensure its performance.

Incorrect handling of the machine may lead to a serious injury or decease.

Before using, be sure to read this manual carefully.

Particularly, the items under "Safety precautions" (See p.1 to p.10).

"WARNING" and "CAUTION" must be read thoroughly.

- * Keep this manual in the case behind the rear door for future reference.
 - * Read the contents of the warranty card attached to the machine.
- If this manual becomes illegible by spot or damage, contact distributor or our office to get new manual.

- Contents -

1.	Safety Precautions	1
2.	Construction	11
	2-1 Outline and part names	11
	2-2 Operating panel, control panel and part names	12
	2-3 Meters	13
	2-4 Use of switches and controllers	18
3.	Transportation and installation	21
	3-1 Transportation of machine	21
	3-2 Installation of machine	22
4.	Connecting the load	24
	4-1 Double voltage	24
	4-2 Cables to be used	26
	4-3 Connecting the load	27
	4-4 Earth leakage relay and Grounding	30
5.	Operation	33
	5-1 Checking prior to operation	33
	5-2 Startup	39
	5-3 Handling during operation	42
	5-4 Shutdown	43
	5-5 Protection device	44
6.	Lubrication, cooling water and fuel	45
	6-1 Engine oil	45
	6-2 Cooling water	46
	6-3 Fuel	46
7.	Handling of battery	47
	7-1 Caution on battery charge	48
	7-2 Connection of booster cable, and installation	49
8.	Periodical checking and maintenance	50
	8-1 Maintenance schedule	51
	8-2 Checking/first 50 hours	54
	8-3 Checking/every 250 hours	56
	8-4 Checking/every 500 hours	59
	8-5 Checking/every 1000 hours	61
	8-6 Table of periodical maintenance and checking	62
9.	Troubleshooting	63
10.	Long-term storage	67
11.	Service data	68
	11-1 Specifications	68
	11-2 AC generator specifications (for custom voltage)	69
	11-3 Outline drawing	70
	11-4 Generator connection diagram	73
	11-5 Engine wiring diagram	76

1. Safety Precautions

In order to ensure safe operation, the following symbols are used for explanation of the machine operation.

The following symbols, found throughout this manual, alert you to potentially dangerous conditions to the operator, service personnel, or the equipment.

 **WARNING:** This symbol refers to a hazard or unsafe practice which can result in severe personal injury or death.

 **CAUTION:** This symbol refers to a hazard or unsafe practice which can result in personal injury or product or property damage.

[Note] : This symbols show handling precautions for effective operation and many years of satisfactory operation.

Some of the items shown by " CAUTION" may also cause death or serious injury.

Be sure to observe all the items, as they are important for safe operation.

- * If the machine is used by an outsider, you are requested to explain him correct handling and advise him to read this instruction manual carefully.
- * Do not modify the machine at your discretion, as it affects the safety, performance or the life of the machine.
- * If the machine is modified or it is used incorrectly against this manual or unauthorized parts are used, the warranty of manufacturer will become invalid.

Safety label

Safety labels are attached to the following positions of the machine.

- * Keep these safety labels clean at all times.
- * When safety labels are spoiled or lost, contact distributor or our office specifying the nameplate No. shown below and ask for new ones. Following numbers are for model 45SPI.

No.	Parts name	Parts number	No.	Parts name	Parts number
1	Safety instruction	B9211 0040	6	Warning: moving part	B9040 0040
2	Warning: exhaust gas	B9042 0000	7	Warning: fire accident	B9045 0000
3	Warning: output voltage	B9311 0050	8	Caution: high temp	B9040 0030
4	Warning: electric leakage	B9111 0040	9	Warning: radiator cap	B9041 0010
5	Warning: electrical shock	B9311 0060	10	Warning: house wiring	B9111 0030

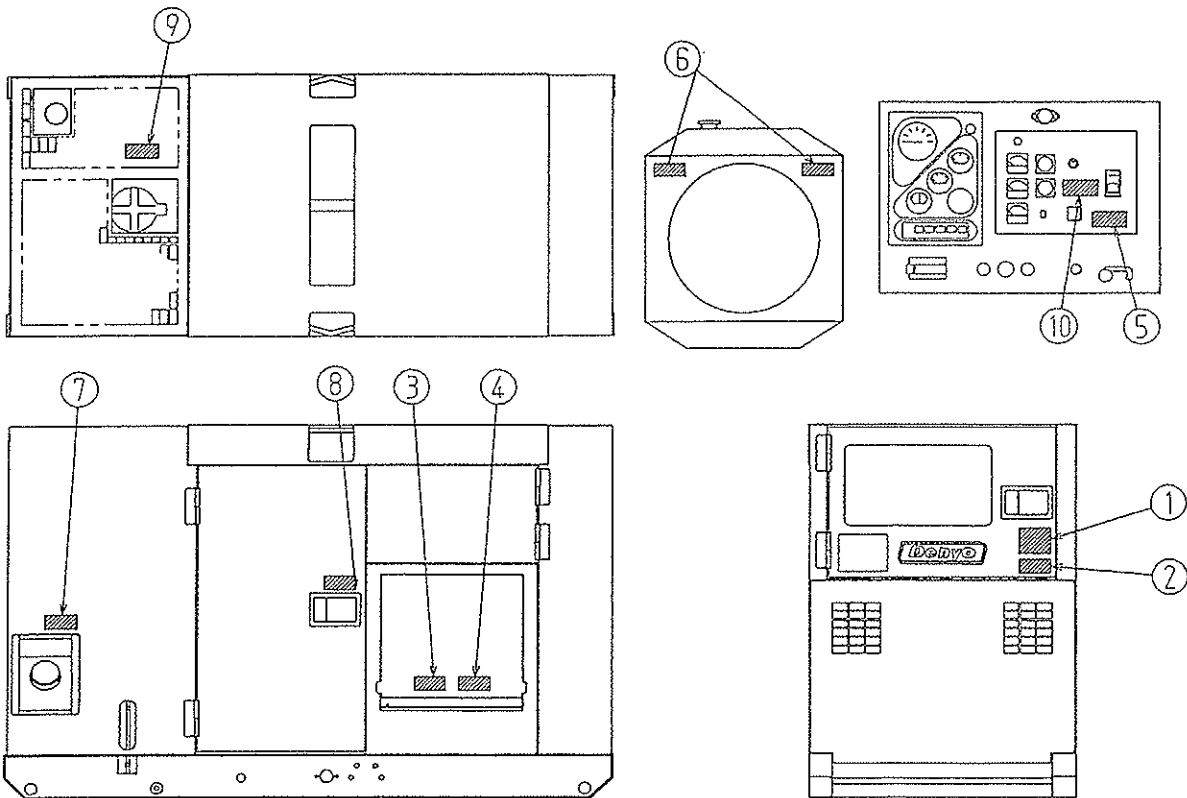

 **WARNING**

ENGINE EXHAUST can kill.

- Insufficient ventilation may lead to death due to lack of oxygen or poisoning by exhaust gases.
- * Do not use the machine in a place of poor ventilation or in a place where exhaust gases stays.
- * Do not use the machine indoors or in storehouse, tunnel, ship hold, tank, etc. of poor ventilation.
- * If it becomes necessary to use the machine in the above places, the exhaust pipe should be extended to a well ventilated place. In this case, use a ventilator to ensure proper ventilation.
- * Do not direct the exhaust outlet to nearby pedestrians and houses.

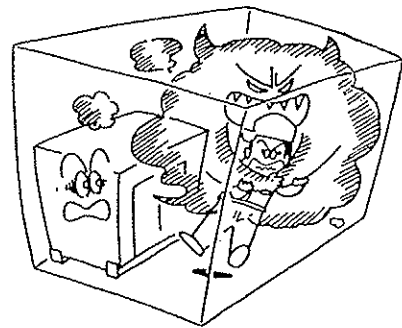
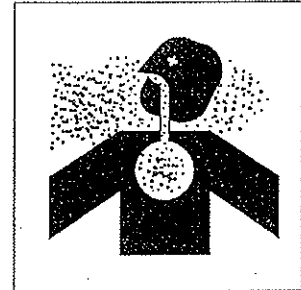

 **WARNING**

ELECTRIC SHOCK can kill.

■ Do not touch the output terminals during operation to prevent decrease due to electric shock.

* Never touch the output terminals during operation.
If your hands or the machine are wet, it will result in a death or serious injury.

* When a wiring work is required, be sure to turn OFF the circuit breaker and stop the machine.

* Keep the output terminal cover closed and the terminal bolts tightened while the machine is running.

* A low voltage is generated even when the machine is in low speed idle operation.

Be sure to stop the machine completely.

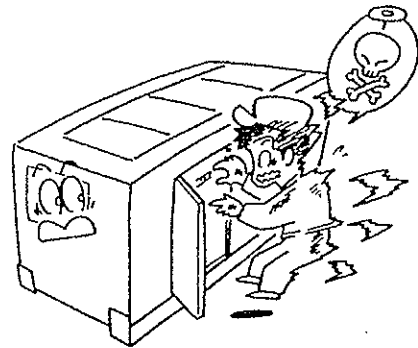
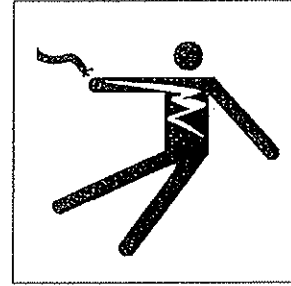

■ Do not touch the electrical parts in the machine during operation, as it may lead to death due to electric shock.

* Always close the control panel and tighten the fixing bolts before operating the machine.

* Always close the side door and lock it before operating the machine.

* When opening the control panel for voltage selection, etc., turn OFF the circuit breaker and stop the machine.

⚠ WARNING

ELECTRIC SHOCK by leak can kill.

- Improper grounding may lead to death due to electric shock.
「4-4.(2) Grounding See p.31」

* Be sure to execute the grounding of the machine and the load according to the local rule.

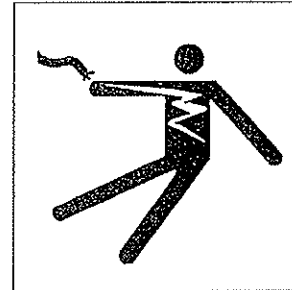

⚠ WARNING

MOVING PARTS can cause severe injury.

- Rotary unit which runs at a high speed is located in the machine.
(Note that it is very dangerous if you touch it.)

* Be sure to close the door and lock it during operation.
* When the door needs to be opened during operation, do not get your hands and head in the machine to prevent them from being caught in the machine which may lead to injury.
* When making check or maintenance of the machine, be sure to stop the machine in advance.

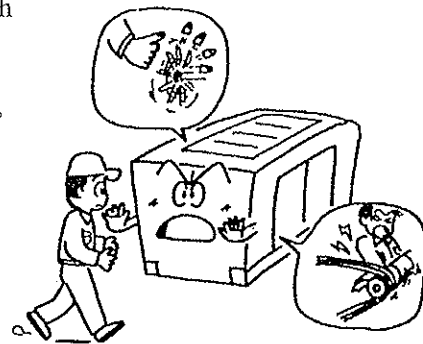

 **WARNING**

DIESEL FUEL can cause fire or explosion.

■ Fuel and oil are flammable. Incorrect handling results in danger of ignition or fire.

- * When fuel needs to be supplied to the machine, be sure to stop the engine. Refrain from smoking. Keep the machine away from fire.
- * Do not leave flammable objects (paper, wood chips, etc.) and hazardous objects (oil, powder, etc.) near the machine.
- * Wipe off spilt fuel and oil.

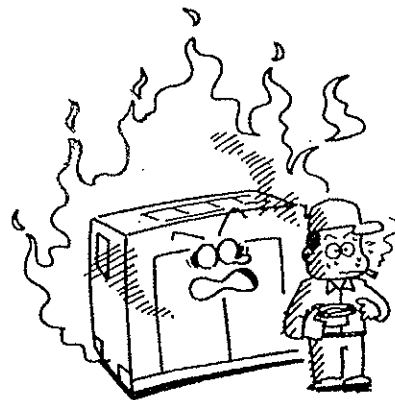
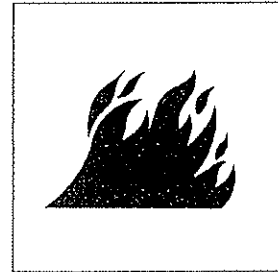

 **WARNING**

HOT COOLANT can cause severe scalds.

■ If the radiator cap is opened while the water temperature is high, steam or hot water will spout out.

- * During operation or immediately after stopping the machine, do not open the radiator cap while the water temperature is high.
- * When cooling water needs to be checked or supplied, wait until the engine is cooled (50°C or less as measured with the water temperature gauge).

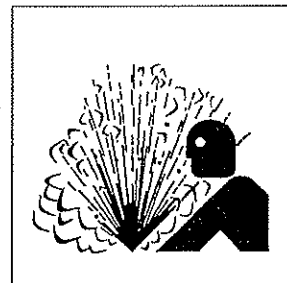

CAUTION

Stacking

- Improper stacking of machines may cause falling or dropping accidents. When stacking other machines on this machine, be sure to observe the following points.

- * Check that the bonnet of the machine is free from damage and that the fixing bolts are not loosened and missing.
- * Put the machine horizontally on a solid foundation which withstands the weight of stacked machines.
- * Machines can be stacked up to 2 stages.
The weight and size of stacked machines should be less than those of this machine.
- * Using square timbers as shown right, put each machine making sure that the weight is even.

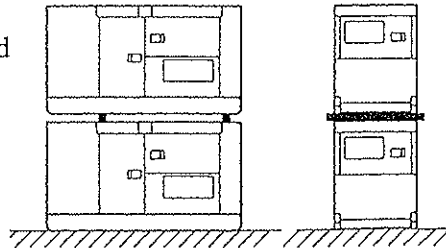

- Do not operate the machines in the state of stacking to prevent falling or dropping accidents.

CAUTION

HOT PARTS can burn skin.

- High temperature units are located in the machine. (Note that these units are very dangerous if they are used incorrectly.)

- * Be sure to close the door and lock it during operation.
- * If the door needs to be opened during operation, do not get your hands and head in the machine to prevent unexpected burns.
- * When making check or maintenance of the machine, be sure to stop the machine.
- * The bonnet is still hot even after the machine is stopped.

Be careful until the engine is completely cooled.

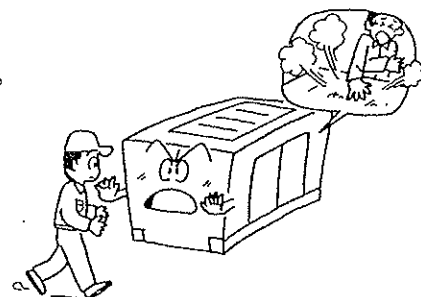
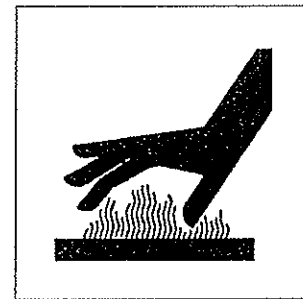

 **CAUTION**

BATTERY

- Battery generates flammable gases.

Improper handling may lead to explosion or serious injury.

- * Battery should be charged in a well ventilated location. Otherwise, flammable gases are accumulated which may be ignited and exploded.
- * When connecting a booster cable, do not jumper the terminals (+ and -). Otherwise, the flammable gases generated from the battery may be ignited and exploded by sparks.
- * For maintenance of the machine, disconnect the ground cable on the ground side.

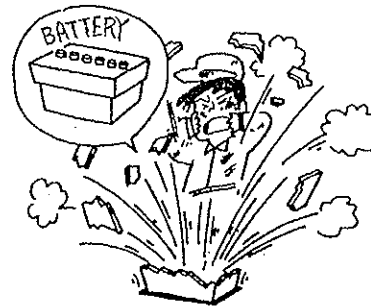
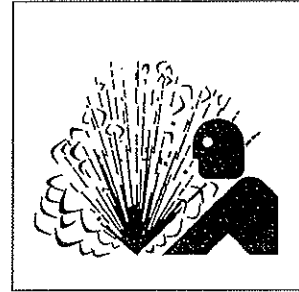

- The battery acid is dilute sulfuric acid. Improper handling will cause unexpected burns.

- * When the battery acid gets on your clothes or skin, wash it out with a large volume of water immediately. If it gets in your eyes, wash with a large volume of water immediately and consult your doctor.
- In the worst case, it will put out your eyes.

- For checking or handling of the battery, be sure to stop the engine and turn OFF the battery switch in advance.

 **CAUTION**

Operator

- Do not operate the machine, if operator is tired too much or drinks some alcohol or take some drugs.
 - * Otherwise, it may cause unexpected accidents or injury.
- During checking or maintenance, be sure to put on suitable clothes and protectors.
 - * Do not put on baggy clothes, necklace, etc., because they are easily caught by projections which may cause injuries.

 **CAUTION**

Noise

- This machine generates large noise, if the door is open. Surrounding to large noise may cause hearing trouble.
 - * Close and lock the door during operation.
 - * If opening the door is necessary during operation, be sure to put on the ear protector.

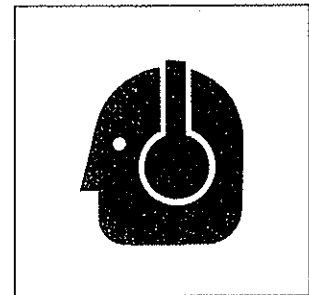

 **CAUTION**

Connection to house wiring

- Before connecting this machine to any building's electrical system, a licensed electrician must install an isolation(transfer) switch.
 - * Serious injury or death may result without this transfer switch.

 **CAUTION**

Transportation

■ Do not lift the machine at the support hook or the ladder because it is not strong enough for lifting and may cause a falling accident.

* When lifting the machine, use the hanger located at the roof center.

* Keep out under the lifted machine.

■ Do not lift or do not transport the machine during operation, as it may cause damage to the fan or serious trouble.

* When loading the machine on the truck or the like, fix the machine firmly by support hooks on the both side.

「11-1. Specifications See p.68」

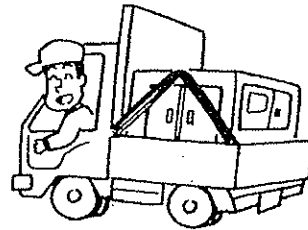
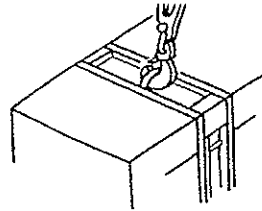

2. Construction

2-1 Outline and part names

Following is 45SPL.

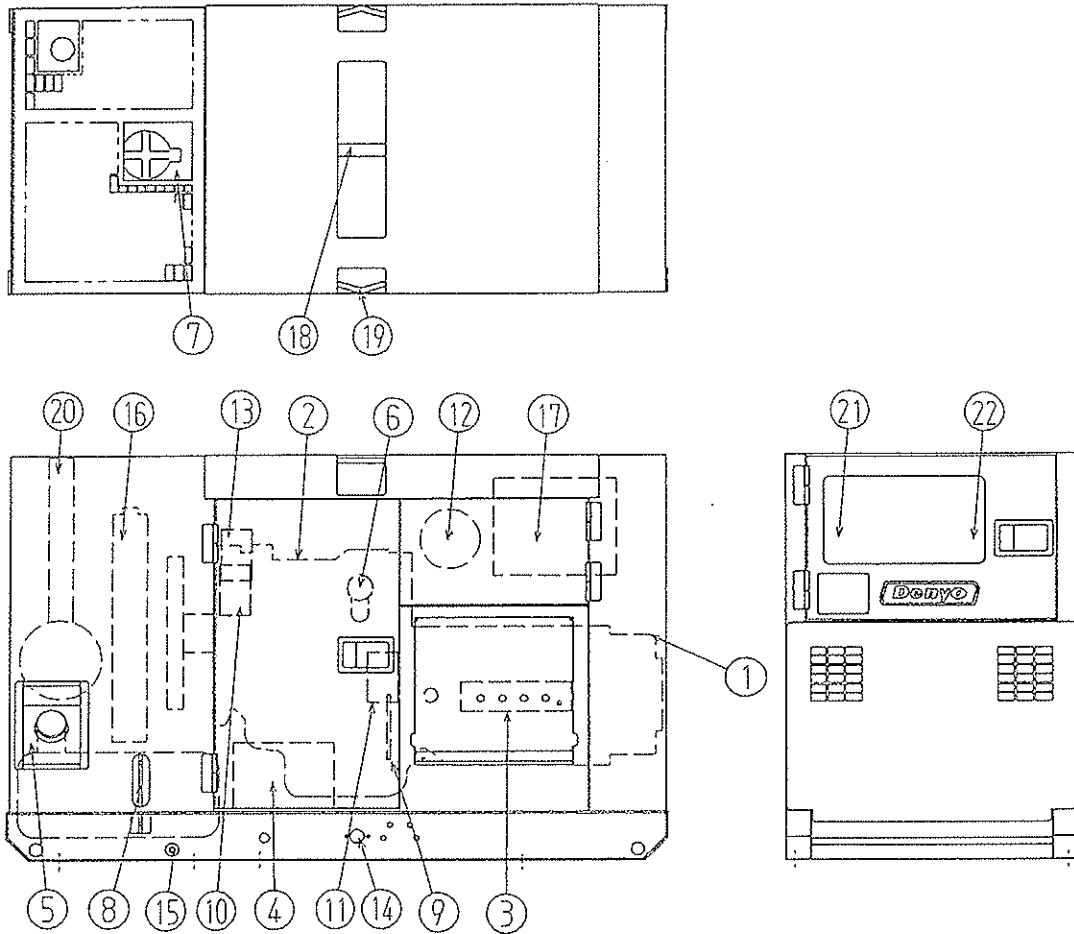

- | | | |
|---------------------|---------------------------------|------------------------|
| 1. AC generator | 9. dipstick | 17. control box |
| 2. diesel engine | 10. fuel filter (opposite side) | 18. hanger rod |
| 3. output terminal | 11. oil filter (opposite side) | 19. support hook |
| 4. battery | 12. air cleaner | 20. exhaust gas outlet |
| 5. fuel in | 13. coolant reserve tank | 21. operating panel |
| 6. engine oil in | 14. oil drain plug | 22. control panel |
| 7. coolant in | 15. fuel drain plug | |
| 8. fuel level gauge | 16. radiator | |

2-2 Operating panel, control panel and part names

Following is 45SPI.

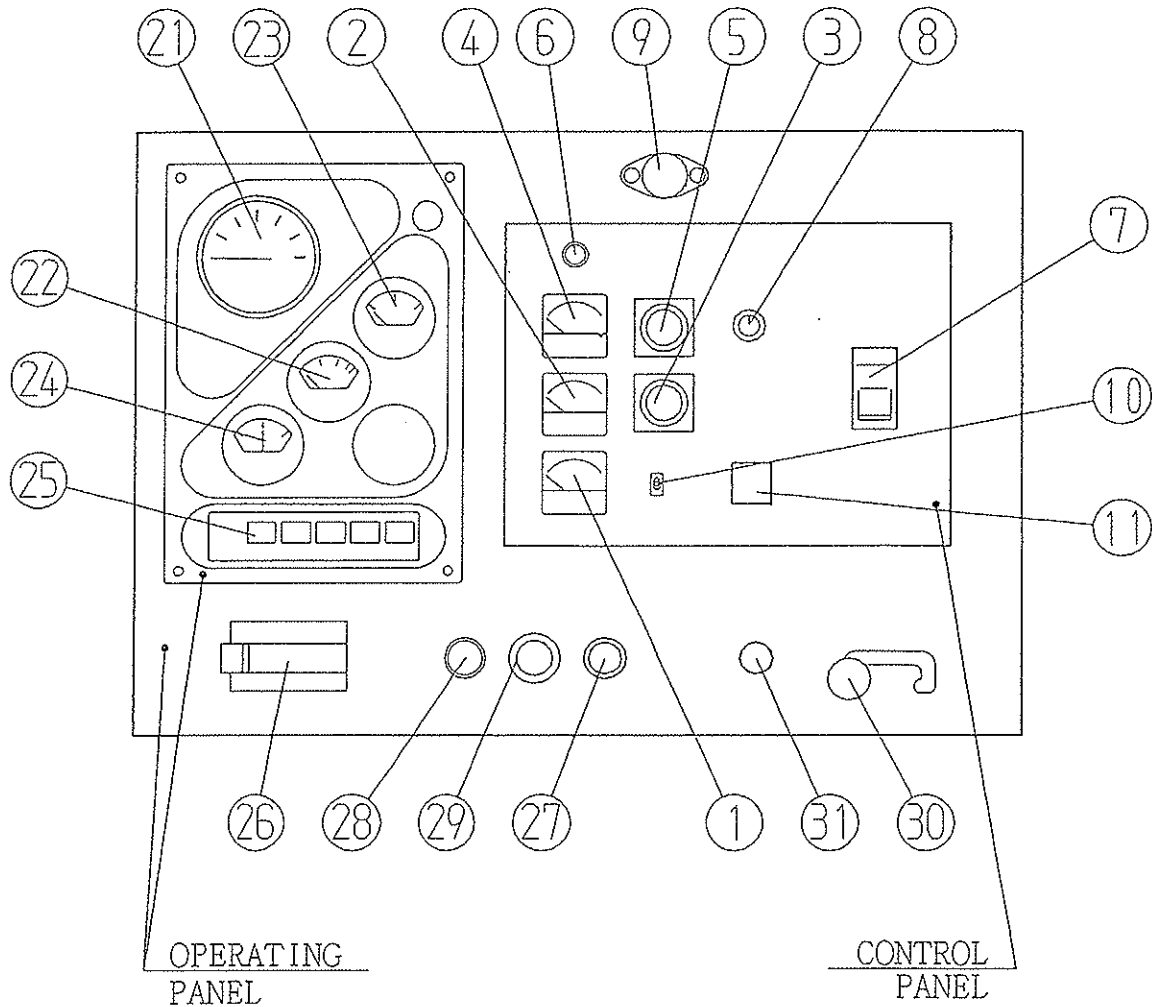

- | | |
|---------------------------------|-------------------------------|
| 1. frequency meter | 21. tachometer |
| 2. AC ammeter | 22. oil pressure gauge |
| 3. ammeter change over switch | 23. water temperature gauge |
| 4. AC voltmeter | 24. charging ammeter |
| 5. voltmeter change over switch | 25. warning lamp unit |
| 6. pilot lamp | 26. battery switch |
| 7. circuit breaker (3-phase) | 27. starter switch |
| 8. voltage regulator | 28. preheat lamp |
| 9. panel light | 29. emergency stop button |
| 10. panel light switch | 30. throttle lever |
| 11. earth leakage relay | 31. frequency adjusting screw |

2-3 Meters

Engine indicators

(1) Tachometer (0-3000rpm)

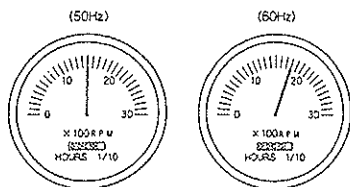

This meter indicates the number of revolutions (per minute) of the engine.

It indicates 1500rpm at 50Hz or 1800rpm at 60Hz.

(2) Hour meter

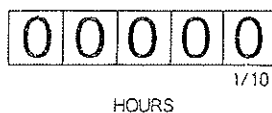

This meter indicates the total running time of the engine. This meter is built in the tachometer.

The hour meter has been set for use at 1500rpm. Accordingly, when the machine is used at 1800rpm, it indicates the total time approximately 20% more than the actual operation time.

(3) Water temperature gauge

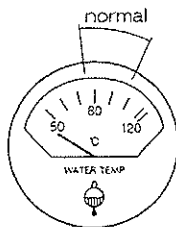

This is normal when it indicates 75 to 95°C during operation.

[Note] If it indicates higher values, turn OFF the load and set the machine in cooling operation by setting the throttle lever to the "START/IDLING" position, and wait until the temperature lowers.

(4) Oil pressure gauge

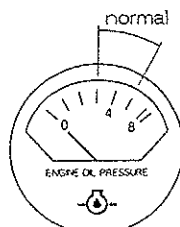

This is normal when it indicates 3 to 5×100kPa during operation.

If the engine is cool, it may indicate higher values at the time of startup. Put the engine in warming up operation and wait until oil pressure becomes normal.

(5) Charging ammeter

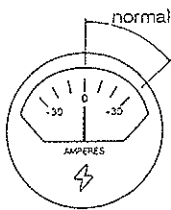

This meter indicates the current supplied by the alternator to batteries.

It is normal when it indicates the range of 0 or +.

Generator indicators

(1) Frequency meter

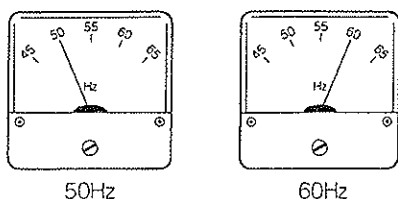

This meter indicates frequency of the output voltage.

Make sure that it indicates 50Hz or 60Hz during operation.

(2) AC ammeter

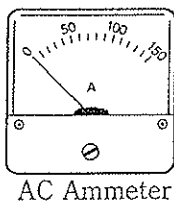

AC Ammeter

This meter indicates AC current flowing into the connected load. Make sure that it is always pointing below the rated current.

When running the three phase and single phase loads together, this meter indicates total current of them.

When running either the three phase or single phase load, this meter indicates the current flowing into the load.

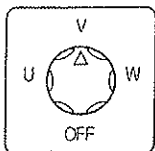

Ammeter change over switch

The current of each phase can be checked using the ammeter change over switch. Ammeter change over switch is provided with the machine 45kVA or larger.

(3) AC voltmeter

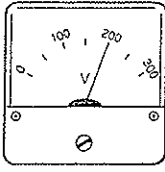

AC Voltmeter

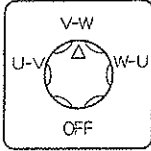

Voltmeter change over switch

This meter indicates AC output voltage. Make sure that it indicates rated voltage.

Line-to-line voltages can be checked using the voltmeter change over switch.

Indication/alarm lamp

(1) Preheat lamp

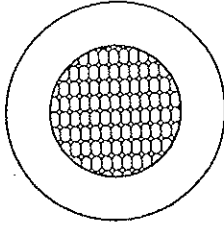

When the starter switch is set in the preheat position, this lamp becomes red heated in about 30 seconds, indicating that the machine has been preheated to be ready for startup.

(2) Warning Lamps

This monitor indicates the following failures, if any one of them occurs.

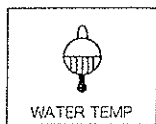
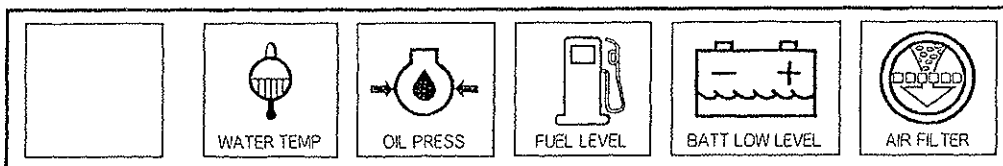

① High jacket water temperature (WATER TEMP)

This lamp goes on when the water temperature rises abnormally. If the lamp goes on during operation, the emergency stop device immediately operates to shut down the engine automatically.

[5-1.(2) Check on engine cooling water See p.35]



② Oil pressure failure (OIL PRESS)

If the machine is in normal operation, this lamp stays off. When the starter switch is turned to "RUN" position to start the engine, the lamp goes on, and when the oil pressure rises after startup, it goes off. If this lamp goes on during operation, the emergency stop device immediately operates to shutdown the engine automatically.

[5-1.(1) Checking on engine oil See p.34]

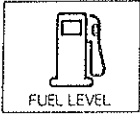

③ Fuel level failure (FUEL LEVEL)

When fuel is running low, this lamp goes on, and it should be supplied at the tank.

「5-1.(4) Check on fuel See p.36」

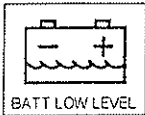

④ Battery acid level failure (BATT LOW LEVEL)

When battery acid is running low, this lamp goes on, and distilled water should be supplied to the battery.

「5-1.(5) Check on battery acid See p.37」



⑤ Air filter blinding (AIR FILTER)

When the air element is blinded, this lamp goes on. Indicating that the element should be immediately cleaned or replaced.

「8-3.(3) Cleaning of air cleaner element See p.56」

「8-5.(2) Replacement of air cleaner element See p.61」

2-4 Use of switches and controllers

Switches

(1) Battery switch

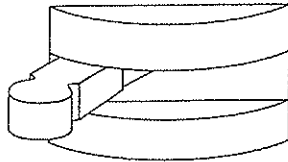

This switch should be set in the "ON" position during operation. And after stop the engine, this switch should be set in the "OFF" position.

[Note] Do not turn this switch to "OFF" position during operation. Otherwise, the engine may not be able to be stopped by normal operation, or it may cause damage to the electric equipment.

(2) Starter switch

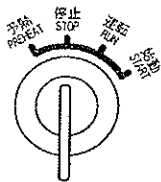

Functions:

① Stop

This switch should be set in this position unless the machine is in operation. The key can be inserted or pulled out in this position.

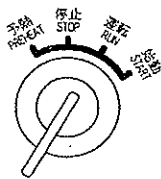

② Run

This switch should be set in this position when the machine is in operation.

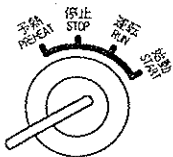

③ Start

This is the position to start the engine. When your hand is released from the key after starting, it is automatically set in the position of "RUN".

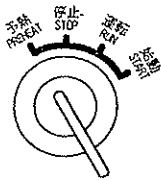

④ Preheat

This is the position to start the engine when the air temperature is low. Set the switch in this position until the preheat lamp becomes red heated, and then set it in the start position.

(3) Speed control device

- Throttle lever

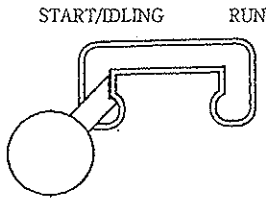

This lever is used to control the engine speed. Set the lever at the "START/IDLING" position for startup or warm up/cooling operation of the engine and at the "RUN" position for constant speed operation of the machine (at 50Hz or 60Hz).

- Frequency adjusting screw

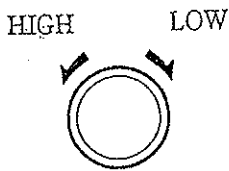

This screw is used to adjust the frequency. With the throttle lever set at the "RUN" position, turn the screw to the "HIGH" side to increase the frequency and to the "LOW" side to decrease it.

(4) Circuit breaker

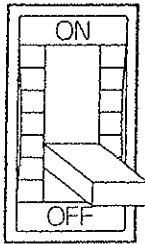

This is a main switch to supply power to a load.

When the load is shorted or in the state of overload, it trips to protect the generator against trouble.

[Note]

Do not use this circuit breaker to turn ON/OFF the load, to prevent damage to the circuit breaker.

When it trips with overcurrent, the handle of the breaker stops between ON and OFF positions. This is what is called the trip condition.

In this case, push the handle down to the OFF position to reset it, or else, it cannot be set in ON position.

Voltage regulator and overcurrent relay

(1) Voltage regulator

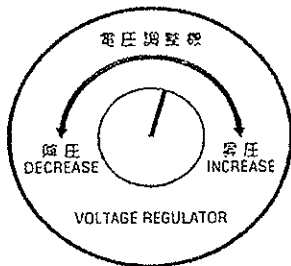

This regulator is used to control the output voltage. Turn the regulator to clockwise to increase the voltage and counter clockwise to decrease it.

Adjust the voltage to the rated voltage with this regulator.

(2) Overcurrent relay

RESET BUTTON

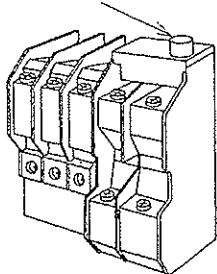

This relay is used to trip the circuit breaker (for 3 phase) when over current flows into the circuit.

If the circuit breaker (for 3-phase) trips and cannot be closed, stop the engine and open the control panel. Then, press the reset button.

[Note]

Do not change the set value unnecessarily.

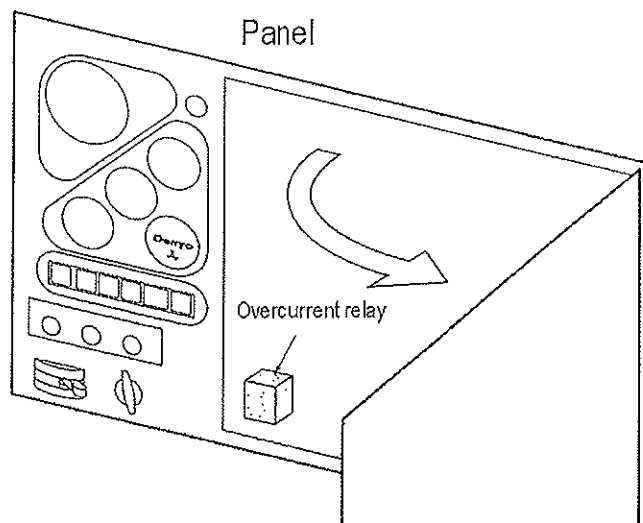

3. Transportation and installation

3-1 Transportation of machine

CAUTION

Transportation

- Do not lift the machine at the support hook or the ladder because it is not strong enough for lifting and may cause a falling accident.

- * When lifting the machine, use the hanger located at the roof center.
- * Keep out under the lifted machine.

- Do not lift or do not transport the machine during operation, as it may cause damage to the fan or serious trouble.

- * When loading the machine on the truck or the like, fix the machine firmly by support hooks on the both side.

The detail as machine size is referred to
「11-1. Specifications See p.68」

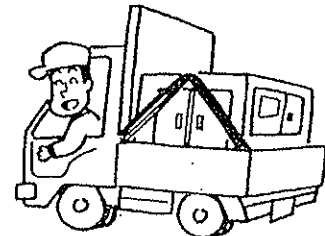
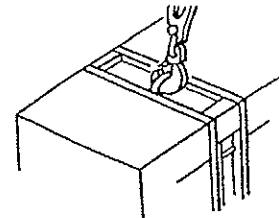

3-2 Installation of machine

WARNING

ENGINE EXHAUST can kill.

■ Insufficient ventilation may lead to death due to lack of oxygen or poisoning by exhaust gases.

- * Do not use the machine in a place of poor ventilation or in a place where exhaust gases stays.
- * Do not use the machine indoors or in storehouse, tunnel, ship hold, tank, etc. of poor ventilation.
- * If it becomes necessary to use the machine in the above places, the exhaust pipe should be extended to a well ventilated place. In this case, use a ventilator to ensure proper ventilation.
- * Do not direct the exhaust outlet to nearby pedestrians and houses.

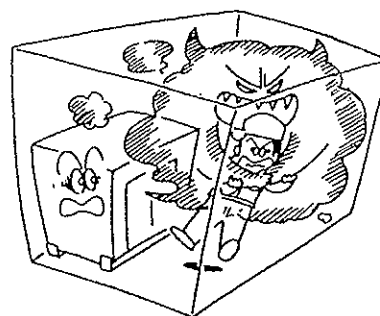
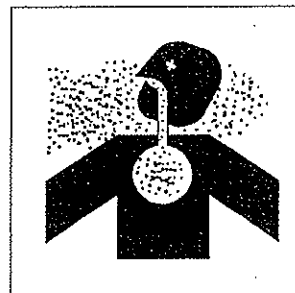

[Note] vibration:

The engine, running, generates vibration during operation of the machine. When installing the machine, be sure to observe the following points.

- ① Install the machine horizontally on a solid foundation.
Operation on an uneven place will generate unusual vibration.
- ② The machine should be installed on a substantial base to prevent claims from nearby living people. For details of the vibration level of the machine and foundation work, contact distributor or our office.

[Note] noise:

The engine is running during operation of the machine.

If the door is open, much noise will be generated. But some noise will stay, when door is closed.

When installing the machine, be sure to observe the following points.

- * Close and lock the door after installation.
- * We recommend to execute the measure for sound level to prevent claims from nearby living people.

Installation procedure

- * Install the machine horizontally on a solid foundation.
- * Provide a space of more than about 1m at the side of the control panel and fuel feed port to ensure correct operation and supply.
- * Provide a space of more than about 1.2m on the left and right sides for check of the engine, oil supply and cable connection work.
- * A sufficient space is required at the top of the machine to allow hot air (exhaust air) from the radiator and exhaust gases to be discharged and to supply water to the radiator.
- * When the machine is operated in a place with much dust or salt, careful maintenance is required to prevent clogging or damage to the radiator or poor insulation of electric parts.

Indoor installation

- * Exhaust gases should be discharged outdoors using an exhaust pipe.
- * Exhaust air should also be discharged outdoors using a duct or the like.
- * Insufficient indoor ventilation will raise the (indoor) temperature and affects the performance of the machine.
- * For details of required volume of ventilation, contact distributor or our office.

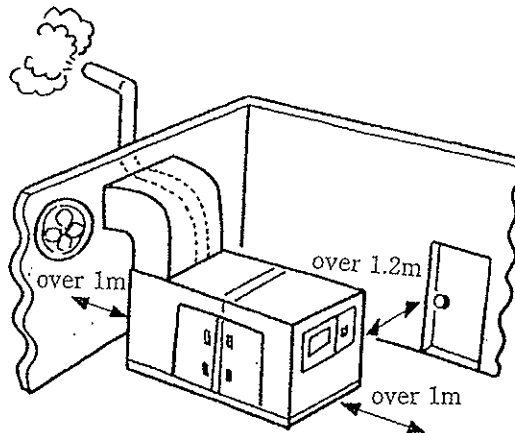

4. Connecting the load

4-1 DOUBLE VOLTAGE

WARNING

ELECTRIC SHOCK can kill.

- Do not touch the circuit inside the machine during operation to prevent decrease due to electric shock.

* When open the control panel or the like for changing the output voltage, turn OFF the breaker and stop the machine in advance.

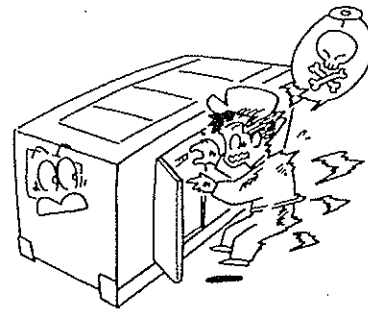
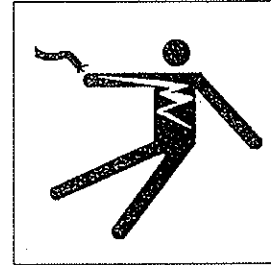

(1) Description

The machine is designed with double voltage specification, which allows the output voltage of 200 V class or 400 V class to be selected with the voltage change over cables.

(2) Method for selecting output voltage

The machine is shipped from the plant with its output voltage normally set at 200/220V unless otherwise specified.

Therefore, select the output the voltage required for work in accordance with the procedure described following :

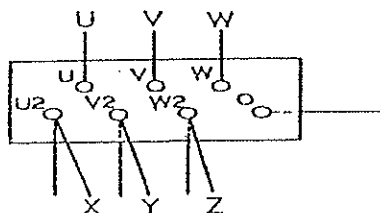

400V class

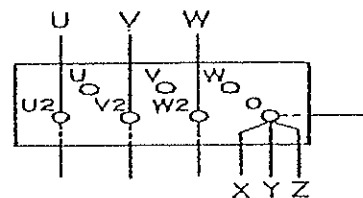

200V class

- ①The voltage change over panel is located on the right door of the rear side, and remove the protecting cover first.
- ②Select the desired output voltage by connecting the change over cables as shown in the figure in the previous page.
- ③As the final step, close the control panel on the control box, close the control panel or mount the protecting cover and close the right door of the rear side.

[Note] Improper connection of the change over cables, it may result in burning of the generator.

In changing the output voltage, tighten the locking nuts securely. Note that insecure tightening of the nuts may result in burning.

Close the control panel or mount the protecting cover to prevent the hazard during operation.

4-2 Cables to be used

Selection of cables:

Use cables having sufficient size in consideration of the allowable current of the cables and the distance between the machine and the load.

If the load current exceeds the allowable current of cables, the cable may be damaged by overheat. Also, if the cables are too small in size for the length, the input voltage of the load drops which lowers the working efficiency or causes failure in operation.

Select the length and size of cable so that the voltage drop "e" obtained by the following equation is within 5% of the rated voltage.

* Equation to obtain 3-phase, 3-wire system voltage drop "e" from the length and size of cable and operating current is as follows.

$$e = \frac{1}{58} \times \frac{L}{S} \times I \times \sqrt{3}$$

where e: voltage drop (V) L: length (m)
S: cable thickness(mm²) I: load current (A)

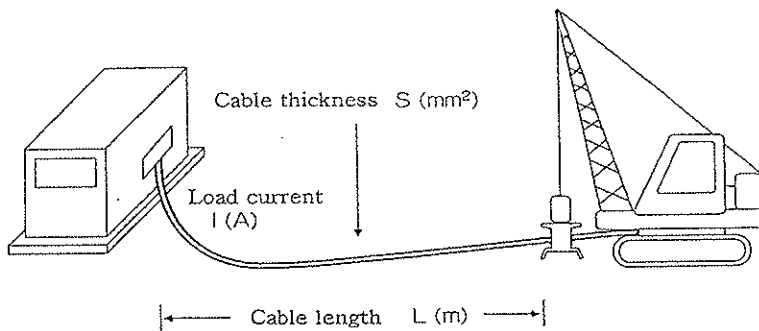

4-3 Connecting the load

ELECTRIC SHOCK can kill.

- Do not touch the output terminals during operation to prevent decrease due to electric shock.

* When a wiring work is required, be sure to turn OFF the circuit breaker and stop the machine.

* When operating the engine, close the output terminal cover.

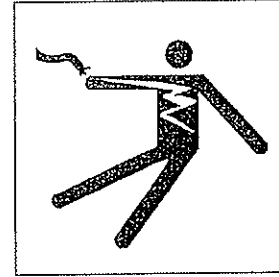

Tighten the fixing bolts before operating the machine.

- Do not use damaged cables to prevent electric shock.

Insufficient tightening of bolts will generate heat at connections which may result in fire accidents.

* When connecting, make sure the connecting cables are normal and connected firmly to the output terminals.

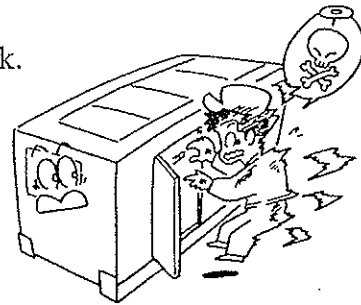

CAUTION

Connection to house wiring

- Before connecting this machine to any building's electrical system, a licensed electrician must install an isolation(transfer) switch.

* Serious injury or death may result without this transfer switch.

(1) Fastening the output terminal

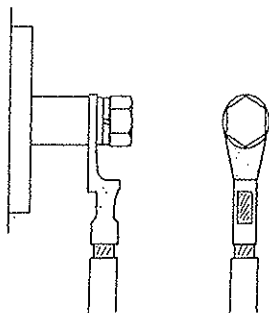

[Note] In connecting the load, tighten locking bolts securely with a spanner or the like to prevent burning.

(2) Connecting three phase output terminal

Connect the load to the output terminal after confirmation of load phase and voltage.



Use U/V/W for three phase load

200/220V or 400/440V

(190V) (380V)

{415V}

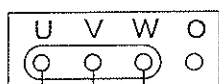

[240V] [480V]

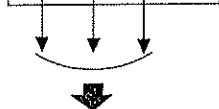

Use O/U,O/V,O/W for single phase load

115/127V or 231/254V

(110V) (219V)

{240V}

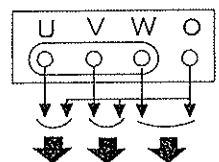

[139V] [277V]

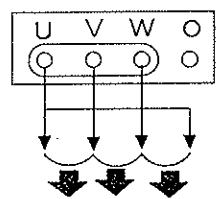

Use U/V,V/W,W/U for single phase load

200/220V or 400/440V

(190V) (380V)

{415V}

[240V] [480V]

(3) Precaution in load connection

- ① Be sure to provide a switch for turning the load ON and OFF between the output terminal block and the load.

Note that the use of the breaker of the machine for turning the load ON and OFF may result in breaker failure.

- ② In connecting the load, be sure to stop the engine and turn OFF the breakers on the control panel and the output terminal block.
- ③ Don't contact the connecting cable to the output terminal of other phase on the output terminal block.
- ④ When the load connection is finished, close the cover of output terminal and tighten by the bolts.

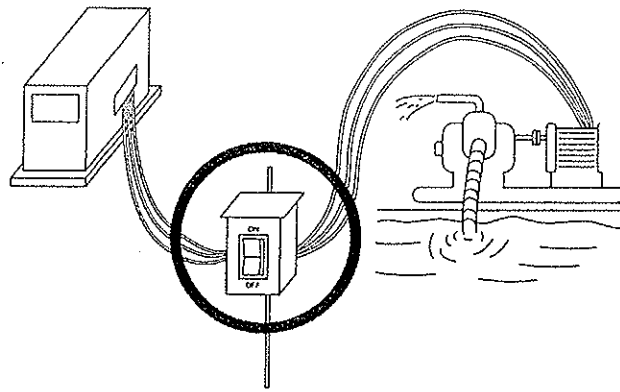

4-4 EARTH LEAKAGE RELAY and Grounding

WARNING

ELECTRIC SHOCK by leak can kill.

- Improper grounding may lead to death due to electric shock. Because the device for leakage protection does not operate effectively.

* Grounding terminal for the earth leakage relay, case grounding terminal and case of the load are grounded.

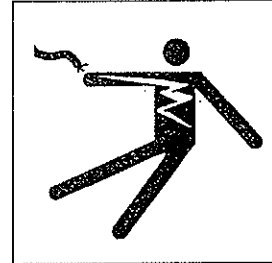

(1) Description of the device

The machine is provided with an earth leakage relay to detect any leakage produced due to such trouble as insulation failure of the load during operation and to cut off the circuit for protection against any accident such as electrocution resulting from the trouble.

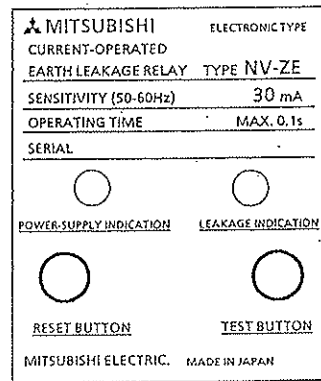

The current sensitivity of this relay is 30 mA.

Improper handling of the relay may lead to unsafe condition in comparison with that does not use the relay.

To ensure further safety, install a leakage relay for each load at the position near the load.

(2) Grounding

Ground as following to operate the earth leakage relay certainly.

■ Grounding of the machine

Ground the grounding terminal for earth leakage relay and case grounding terminal according to the below.

① Grounding of the grounding terminal for earth leakage relay

If grounding described below does not comply with the local rule, stricter of the two shall apply.

Use the grounding wire which sectional area is 5.5mm^2 or larger.

Usually it is possible that using attached grounding rod. But if grounding resistance is over $100\ \Omega$, provide the grounding rod which surface area contacted the ground is large.

② Grounding of the case grounding of the machine

Use the grounding wire which sectional area conforms to the local rule.

Provide the grounding rod to satisfy the grounding resistance which conforms to the local rule.

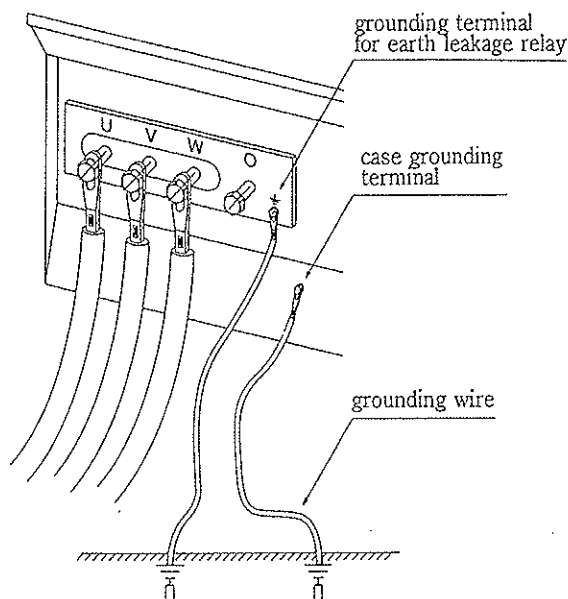

■ Grounding of the load equipment

As in the case of the machine, execute grounding work on the load equipment case. Provide the grounding rod to satisfy the grounding resistance which conforms to the local rule.

[Note] The installation of a leakage relay on the machine can not become a reason for elimination of the need for the load side grounding.

The load side grounding is indispensable for earliest possible detection of any leakage caused in the generator. The absence of such grounding requires any leakage to be detected by current flowing through the human body and is very dangerous because the sensitivity of leakage relay provided on the machine is not sufficient for detection of such current.

■ Precaution in grounding

- ① Select a shady and highly moist place, and bury the grounding rod in such way that its top end is completely hidden in the ground.
- ② If burying the grounding rod on the place that many pedestrians walk on, clamp the lead wire to prevent catching on it.
- ③ If the lead wire is not long enough for the connection, connect it as directed below:
 - (1) Connect the lead wire and the extension wire by soldering or sleeve coupling securely and apply insulating tape to the connection.
 - (2) Do not bury the connection in the ground.
- ④ Avoid the places within 2m of lightning conductor grounding location for burying of grounding rod.
- ⑤ Do not use a telephone set grounding conductor.

■ Operation check

For safety reasons, check on the operation of the leakage relay at the startup of the machine according to the procedure described below:

- ① Start up the machine according to
「5-2 Startup See p.39」
- ② Make sure that all breakers of the load side are "OFF".
- ③ Set the breaker of three phase and single phase to "ON".
- ④ Press the TEST button on the leakage relay.
If this causes the LEAK lamp (red) on the leakage relay to go on and the breakers to be activated, the leakage relay can be regarded as operating normally.
- ⑤ Press the RESET button and return the breaker to the "OFF" position. This allows the breaker to be turned to "ON" again.

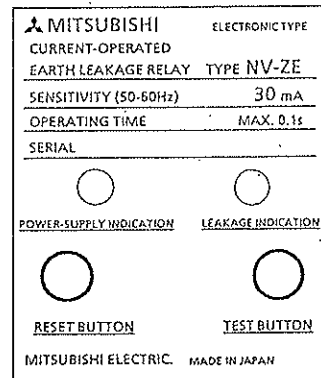

The leakage relay, once it is activated, holds its activated state until the RESET button is pressed or the machine is stopped.

(3) Action for operation of the leakage relay

When the leakage relay is activated, then stop the engine, and measure the insulation resistance several parts and repair the leak spot before restart the engine.

5. Operation

- From pre-start check to shut down -

Be sure to check the machine prior to starting.

1. Pre-start check : Check oil, cooling water, fuel and so on.
2. Periodical check: Check each part of the machine according to operating time.
3. Startup: Check the surroundings of the machine for safe operation.

Use a sign before startup.

4. Operation:  In the machine there are moving parts, high temperature parts and high voltage parts. Before operating, close the door and lock the side door for safe operation and for prevention of noise.

[Note] If the warning lamp lights, stop the engine and check the cause of it.

[Note] Check for leaks of oil, water, exhaust gases, and for unusual noise.

5. Shut down

5-1 Checking prior to operation

WARNING

MOVING PARTS can cause severe injury.

- Rotary unit which runs at a high speed is located in the machine.

(Note that it is very dangerous if you touch it.)

- * Be sure to close the door and lock it during operation.
- * When making check or maintenance of the machine, be sure to stop the machine in advance.

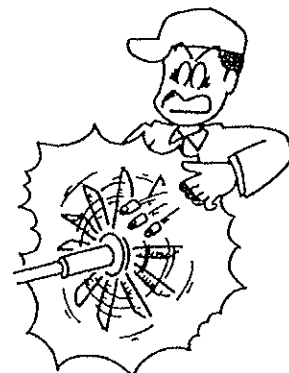
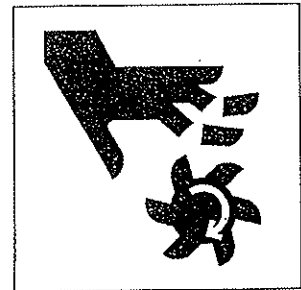

- To prevent unexpected trouble, be sure to check the following points.

- (1) Check on engine oil (lubricating oil)
- (2) Check on engine cooling water
- (3) Checking on fan belt
- (4) Checking on fuel
- (5) Checking on battery acid
- (6) Checking on grounding for electric shock protection
- (7) Checking for leakage of oil and water
- (8) Checking for loose parts
- (9) Removal of foreign objects in machine

Inspection:

- (1) Checking on engine oil

(Read the instruction manual for the engine furnished separately.)

- ① Checking the level of engine oil by the dipstick. Make sure the oil level is always between H and L.
- ② When it is below the low limit, supply oil immediately.
- ③ At the same time, check condition of oil by the dipstick.

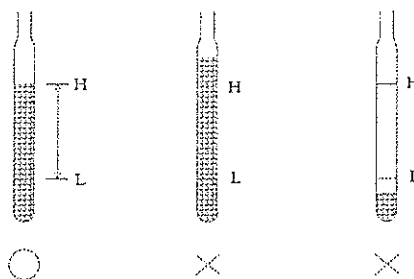
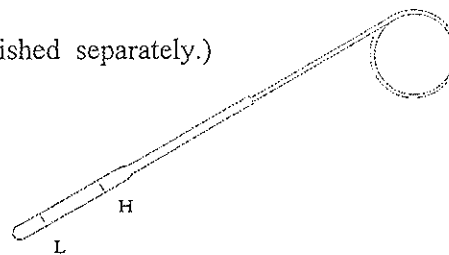

[Note]

Oil is consumed gradually during operation. When the machine is to be used continuously for a long time, be careful with lack of oil.

(2) Check on engine cooling water

(Read the instruction manual for the engine furnished separately.)

WARNING

HOT COOLANT can cause severe scalds.

■ If the radiator cap is opened while the water temperature is high, steam or hot water will spout out.

* During operation or immediately after stopping the machine, do not open the radiator cap while the water temperature is high.

* When cooling water needs to be checked or supplied, wait until the engine is cooled (50°C or less as measured with the water temperature gauge).

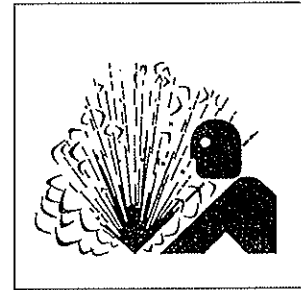

- ① Check (to see) that cooling water in the reserve tank is within the range of FULL-LOW.
- ② When it is below the low limit, supply (additional) water immediately.
- ③ Normally, only the water level of the reserve tank needs to be checked.

But, the radiator cap should be opened once a week to check that water is full in the radiator.

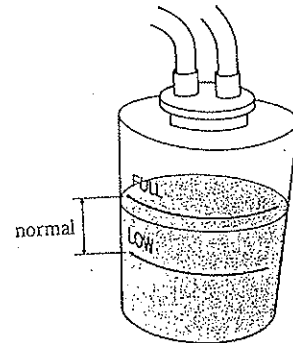

[Note]

When closing the radiator cap after water level is checked or water is supplied, turn the cap fully clockwise so that it can be firmly tightened.

Otherwise, cooling water is evaporated which results in serious damage to the engine.

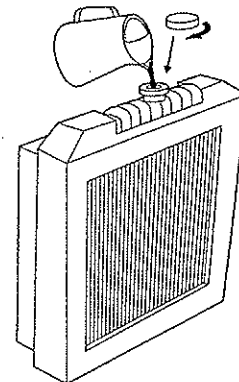

(3) Check on fan belt

(Read the instruction manual for the engine furnished separately.)

- ① Check the belt for tension and elongation.

Also, check it for damage. Replace if necessary.

- ② For adjustment or replacement of the belt, refer to the instruction manual for the engine.

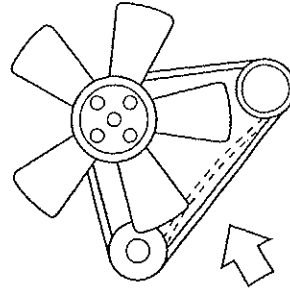

Press (about 6kg) the position shown by arrow mark (middle of belt) with your thumb. The bend should be within the range of 10-15mm.

(4) Check on fuel

- ① Be sure to check the quantity of fuel prior to operation to prevent lack of fuel during operation.

- ② Loosen the drain plug of the fuel tank from time to time, and remove sediments and water at the bottom of the tank.

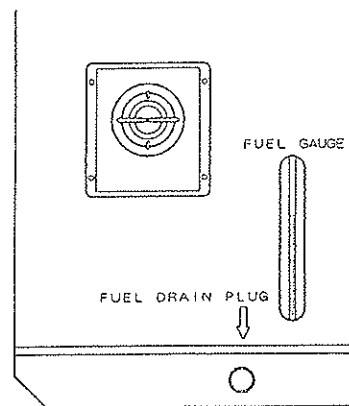

(5) Check on battery acid

 **CAUTION**

BATTERY

■ The battery acid is dilute sulfuric acid. Improper handling will cause unexpected burns.

* When the battery acid gets on your clothes or skin, wash it out with a large volume of water immediately. If it gets in your eyes, wash with a large volume of water immediately and consult your doctor.

- In the worst case, it will put out your eyes.

Remove the battery acid plug(cap) and check the liquid level (10-12mm above the electrodes). Supply distilled water if necessary.

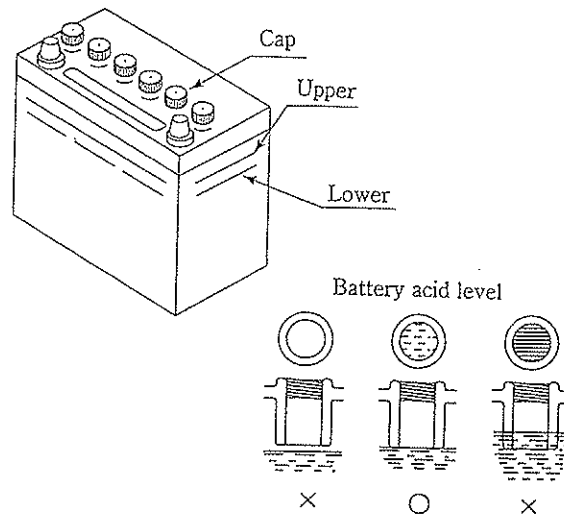

(6) Check grounding for electric shock protection

Make sure that the case grounding of the machine and the load are certainly.

「4-4.(2)Grounding See p.31」

Do not ground directly 「O」 terminal.

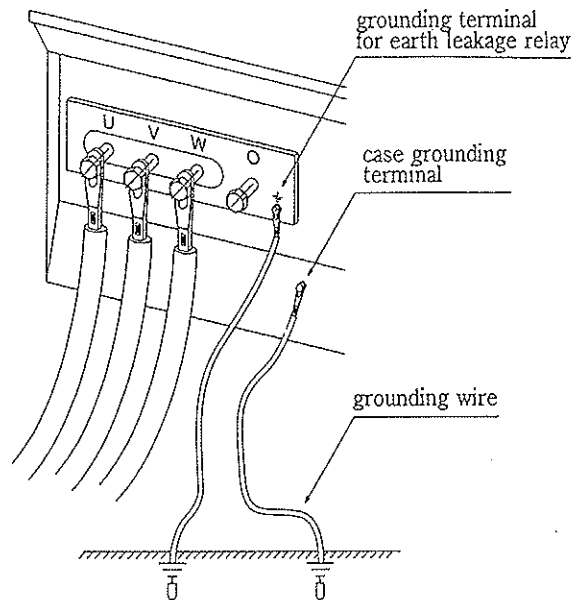

(7) Check for leak of water and oil

Check the machine for the trace of leak of oil or water. If a leak is found, check the location of leak and stop it. When the leak cannot be stopped, contact our service factory.

(8) Check for loose parts

Check for loose bolts and nuts. Loose parts should be tightened firmly. Particularly, make check on (the fitting of air cleaner, muffler, turbo-charger, etc.), disconnection of electric wiring, short-circuit and loose terminals.

(9) Removal of foreign objects in machine

- * Check that tools and cleaning cloth are not left in the machine. Remove if necessary.
- * Check the surroundings of the muffler and engine for presence of dust and flammable objects. Remove if necessary.
- * Check that the cooling air inlet and the cooling air outlet of the machine are not clogged with dust or other objects. Remove if necessary.

5-2 Startup

Following is flow of startup.

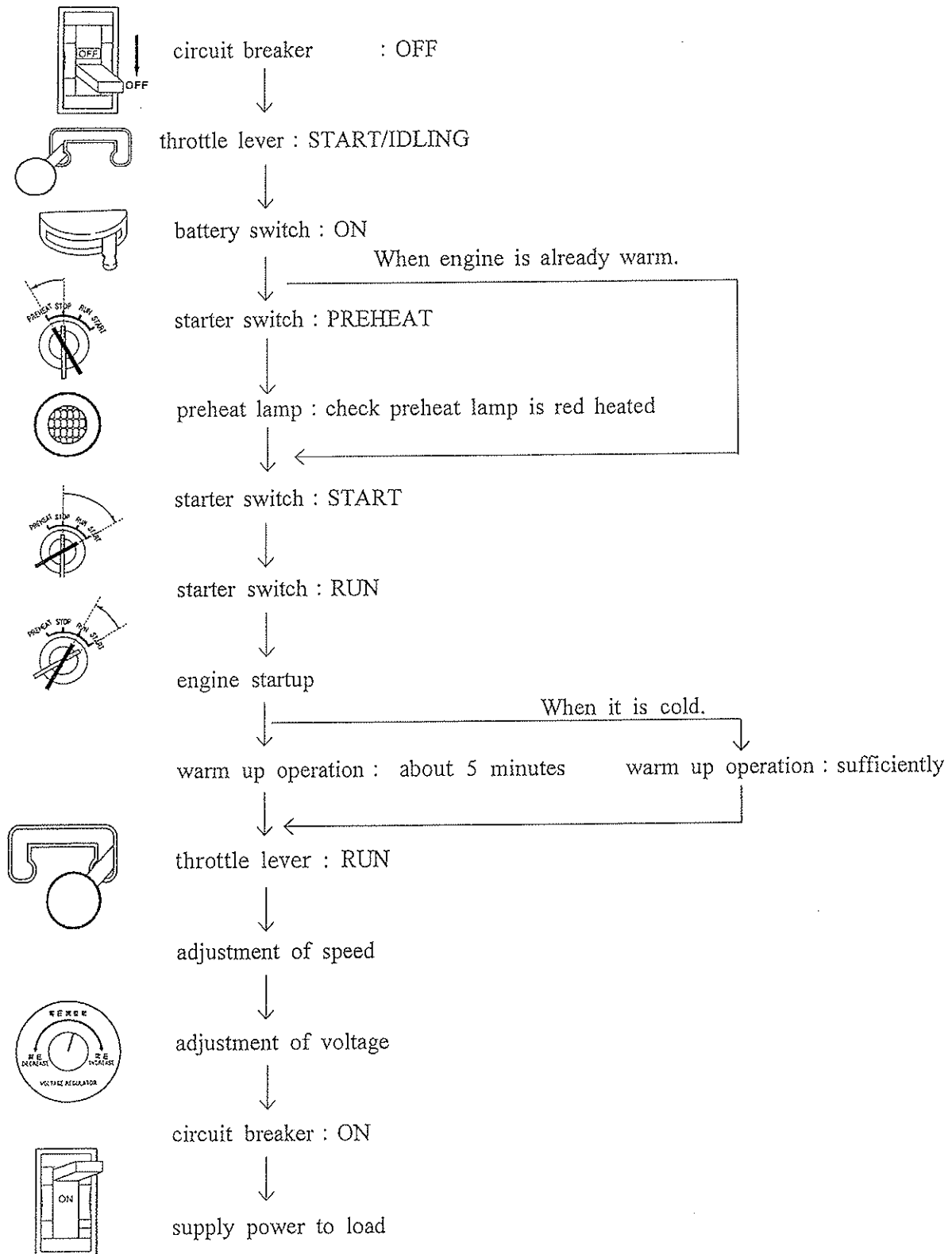

CAUTION

- * Do not start the engine when the machine and the load circuit breaker are ON, or else, power is supplied to the load at the start of the engine which causes electric shocks or trouble in the load.

Startup procedure:

- (1) Make sure that the circuit breakers of the machine and the loads are all OFF.
- (2) Turn the battery switch to ON and set the throttle lever in the "START / IDLING" position.
- (3) Set the starter switch in "Preheat" position. This switch must be ON until the preheat lamp becomes red heated. Turn the starter switch to "START" position until engine starts.
[Note]
If the engine is warm, the preheat operation is not required.
- (4) If engine starts up, set free the starter switch. Make sure that 「Oil Pressure Failure」 in the warning lamp unit goes off.
- (5) Drive the machine for warming up the engine for about 5 minutes at the "START / IDLING" position of the throttle lever.

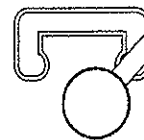
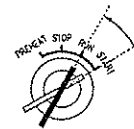
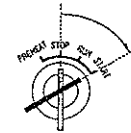
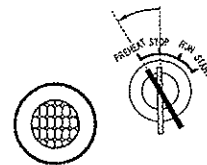
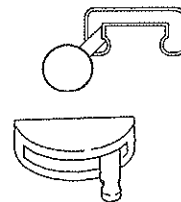
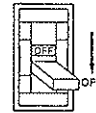

- (6) After warming up the engine, set the throttle lever to the "RUN" position. And check on the idling speed is as specified in the following table by the frequency meter. If the idling speed is required, adjust the idling speed by the frequency adjusting screw.

Commercial frequency	Frequency (Idling speed)
Operation at 50Hz	52.5Hz(1575rpm)
Operation at 60Hz	62.5Hz(1875rpm)

If the idling speed set above speed, frequency becomes nearly 50Hz or 60Hz in the rated load.

- (7) Set the voltage to the rated by the voltage regulator, and turn the breaker to "ON". The machine starts power transmission state.

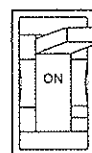
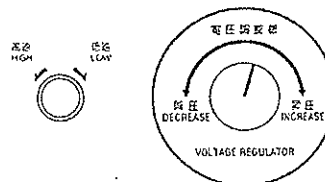

5-3 Handling during operation

(1) Checking after startup

- ① Make sure that each meter and lamp are normal.

normal : warning lamp is all off
(See P.16)

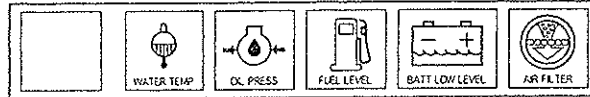

- ② Make sure that the color of exhaust gases from the engine is normal.

Check for unusual noise and vibration.

Color of exhaust gases

- Colorless or light blue: Normal
- Black: Abnormal, incomplete combustion
- White: Abnormal, combustion of oil due to failure of oil

- ③ Check on the operation of the earth leakage relay.

(See P.32)

(2) Adjustment during operation

Set the tachometer and frequency meter to the rated by the throttle handle.

Set the voltmeter to the rated by the voltage regulator.

[Note]

- * Do not set the throttle lever in "START/IDLING" position or do not decrease the speed by the frequency adjusting screw during operation of the load, or else, the generator voltage and frequency will go down, resulting in failure in operation of the load device or any other trouble.

Do not turn the battery switch to "OFF" position or do not remove the battery, or else, engine will not stop normally or resulting in trouble of electrical equipment.

5-4 Shut down

(1) Turn OFF the circuit breaker of the load.

circuit breaker of the load

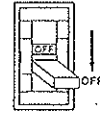

(2) Turn OFF the circuit breaker of the machine.

Circuit breaker of the machine

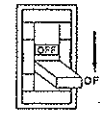

(3) Set the throttle lever in "START / IDLING" position and put the machine in cooling operation for about 5 minutes.

cooling operation for about 5 min.

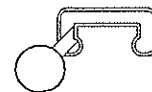

throttle lever

(4) Set the starter switch in "STOP" position.

The engine will stop immediately.

starter switch

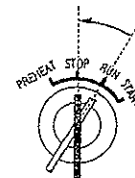

(5) Turn the battery switch to "OFF" .

[Note]

Do not leave the machine keeping the battery switch at "ON", the battery is discharged.

battery switch



OFF

(6) Remove the key from the starter switch and keep it at hand.

(7) Check the amount of fuel. Supply additional fuel if necessary.

(8) Check for leakage of oil, fuel and water.

[Note]

For emergency stop, keep pushing the "EMERGENCY STOP" button until the engine stops.

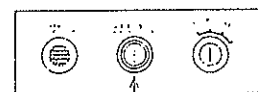

emergency stop button

5-5 Protection device

Protection devices and emergency stop devices are provided for protection of the machine against trouble during operation. When the running caution lamp lights, stop the engine immediately. Check and remove the cause of trouble.

Table of protection device

warning	action	turn OFF the circuit breaker	stop the engine	indicate by warning lamp	function
high jacket water temperature (WATER TEMP)	—	—	○	○	When the cooling water temperature rises abnormally, the device acts. Set point : 105°C
oil pressure failure (OIL PRESS)	—	—	○	○	When the oil pressure falls abnormally, the device acts. Set point : 98 kPa
fuel level failure (FUEL LEVEL)	—	—	—	○	When fuel supply is necessary because of fuel shortage, the device acts.
battery acid level failure (BATT LOW LEVEL)	—	—	—	○	When the battery acid is failure, the device acts.
air filter blinding (AIR FILTER)	—	—	—	○	When replace or cleaning of air filter is necessary because of blinding of filter, the device acts
overcurrent	○	—	—	—	When overcurrent flows, the device acts
earth leakage	○	—	—	○	When electric leakage, the device acts Current sensitivity : 30mA

6. Lubrication, cooling water and fuel

6-1 Engine oil

Use specified engine oil, otherwise, it greatly affects the startup operation and life of the engine.

(1) Kind of oil

Use oil, CD class or higher, classified by API service.

(2) Oil viscosity

Recommended oil viscosity is SAE 10W-30, all-season type.

Use oil according to ambient temperature referring to the table below.

Ambient temperature (°C)						
-30	-20	-10	0	10	20	30
		← SAE 20 →				
			← SAE 30 →			
←	SAE 5W-20			→		
←		SAE 10W-30				→
←		SAE 15W-40				

[Note]: Do not mix with different kind of oil, or else, it deteriorates the oil quality.

(3) Quantity of replacement oil

Total oil quantity	DCA-45SPI	14.0 L (0.7)
	DCA-60SPI	19.3 L (1.0)
	DCA-70SPI	19.3 L (1.0)
(Value in parentheses is filter capacity.)		

6-2 Cooling water

(1) Water for cooling

Use the mixture of the good quality soft water like city water and the Long Life Coolant (LLC) of anti-freeze and anti-rust for the aluminum radiator.

Percentage of LLC must be 30% to 50%, Under the 30%, the anti-rust effect will decrease, and over the 50%, the anti-freeze effect will decrease.

The following percentages are recommended for each ambient temperature;

30%: -10°C

40%: -20°C

50%: -30°C

In case of replenishment, use LLC of the same brand and the same density. Normally LLC should be replaced every 2 year.

(2) Total quantity of cooling water

Total cooling water quantity	DCA-45SPI	1 3 . 9 L (1.0)
	DCA-60SPI	1 9 . 0 L (1.0)
	DCA-75SPI	2 2 . 9 L (2.4)

(Value in parentheses is reserve tank capacity.)

6-3 Fuel

(1) Fuel to be used

#2 Diesel Fuel

[Note]

If other kinds of fuel is used or fuel being used contains water or dust, it deteriorates the engine performance or leads to a serious trouble.