

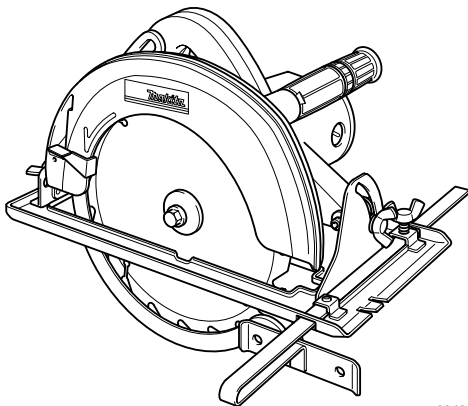

# Circular Saw

MODEL N5900B



004321

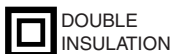

## I N S T R U C T I O N   M A N U A L

**⚠ WARNING:**

For your personal safety, READ and UNDERSTAND before using.  
SAVE THESE INSTRUCTIONS FOR FUTURE REFERENCE.

# SPECIFICATIONS

Model		N5900B
Blade diameter		235 mm
Max. Cutting depth	at 90°	85 mm
	at 45°	60 mm
	at 50°	53 mm
No load speed (min <sup>-1</sup> )		4,100
Overall length		380 mm
Net weight		7.0 kg
Safety class		□ /II

- Due to our continuing programme of research and development, the specifications herein are subject to change without notice.
- Note: Specifications may differ from country to country.

## SYMBOLS

END201-1

The following show the symbols used for the tool. Be sure that you understand their meaning before use.



.....Read instruction manual.



.....DOUBLE INSULATION

## Intended use

The tool is intended for performing lengthways and crossways straight cuts and mitre cuts with angles in wood while in firm contact with the workpiece.

## Power supply

The tool should be connected only to a power supply of the same voltage as indicated on the nameplate, and can only be operated on single-phase AC supply. They are double-insulated in accordance with European Standard and can, therefore, also be used from sockets without earth wire.

# SAFETY INSTRUCTIONS

ENA001-2

## **WARNING:**

**When using electric tools, basic safety precautions, including the following, should always be followed to reduce the risk of fire, electric shock and personal injury. Read all these instructions before operating this product and save these instructions.**

### **For safe operations:**

- 1. Keep work area clean.**  
Cluttered areas and benches invite injuries.
- 2. Consider work area environment.**  
Do not expose power tools to rain. Do not use power tools in damp or wet locations. Keep work area well lit. Do not use power tools where there is risk to cause fire or explosion.
- 3. Guard against electric shock.**  
Avoid body contact with earthed or grounded surfaces (e.g. pipes, radiators, ranges, refrigerators).
- 4. Keep children away.**  
Do not let visitors touch the tool or extension cord. All visitors should be kept away from work area.
- 5. Store idle tools.**  
When not in use, tools should be stored in a dry, high or locked up place, out of reach of children.
- 6. Do not force the tool.**  
It will do the job better and safer at the rate for which it was intended.
- 7. Use the right tool.**  
Do not force small tools or attachments to do the job of a heavy duty tool. Do not use tools for purposes not intended; for example, do not use circular saws to cut tree limbs or logs.
- 8. Dress properly.**  
Do not wear loose clothing or jewellery, they can be caught in moving parts. Rubber gloves and non-skid footwear are recommended when working outdoors. Wear protecting hair covering to contain long hair.
- 9. Use safety glasses and hearing protection.**  
Also use face or dust mask if the cutting operation is dusty.
- 10. Connect dust extraction equipment.**  
If devices are provided for the connection of dust extraction and collection facilities ensure these are connected and properly used.
- 11. Do not abuse the cord.**  
Never carry the tool by the cord or yank it to disconnect it from the socket. Keep the cord away from heat, oil and sharp edges.
- 12. Secure work.**  
Use clamps or a vice to hold the work. It is safer than using your hand and it frees both hands to operate the tool.
- 13. Do not overreach.**  
Keep proper footing and balance at all times.
- 14. Maintain tools with care.**  
Keep cutting tools sharp and clean for better and safer performance. Follow instructions for lubrication and changing accessories. Inspect tool cord periodically and if damaged have it repaired by an authorized service facility. Inspect extension cords periodically and replace, if damaged. Keep handles dry, clean and free from oil and grease.
- 15. Disconnect tools.**  
When not in use, before servicing and when changing accessories such as blades, bits and cutters.
- 16. Remove adjusting keys and wrenches.**  
Form the habit of checking to see that keys and adjusting wrenches are removed from the tool before turning it on.
- 17. Avoid unintentional starting.**  
Do not carry a plugged-in tool with a finger on the switch. Ensure switch is off when plugging in.
- 18. Use outdoor extension leads.**  
When tool is used outdoors, use only extension cords intended for outdoor use.
- 19. Stay alert.**  
Watch what you are doing. Use common sense. Do not operate tool when you are tired.
- 20. Check damaged parts.**  
Before further use of the tool, a guard or other part that is damaged should be carefully checked to determine that it will operate properly and perform its intended function. Check for alignment of moving parts, free running of moving parts, breakage of parts, mounting and any other conditions that may affect its operation. A guard or other part that is damaged should be properly repaired or replaced by an authorized service center unless otherwise indicated in this instruction manual. Have defective switches replaced by an authorized service facility. Do not use the tool if the switch does not turn it on and off.
- 21. Warning.**  
The use of any accessory or attachment, other than those recommended in this instruction manual or the catalog, may present a risk of personal injury.
- 22. Have your tool repaired by a qualified person.**  
This electric tool is in accordance with the relevant safety requirements. Repairs should only be carried out by qualified persons using original spare parts, otherwise this may result in considerable danger to the user.

# ADDITIONAL SAFETY RULES FOR TOOL

ENB036-4

1. Wear hearing protection.
2. **Keep Guards In Place and In Working Order.** Never wedge or tie lower guard open. Check operation of lower guard before each use. Don't use if lower guard does not close briskly over saw blade.  
**CAUTION:** If saw is dropped, lower guard may be bent, restricting full return.
3. Do not use blades which are deformed or cracked.
4. Do not use blades made of high speed steel.
5. Do not stop the blades by lateral pressure on the saw blade.
6. **Keep Blades Clean and Sharp.** Sharp blades minimize stalling and kickback.
7. **DANGER:**  
**Keep Hands Away From Cutting Area.** Keep hands away from blades. Don't reach underneath work while blade is rotating. Don't attempt to remove cut material when blade is moving.  
**CAUTION:** Blades coast after turn off.
8. **Support Large Panels (Fig. 1 & 2).** Large panels must be supported as shown in Fig. 1 to minimize the risk of blade pinching and kickback.  
When cutting operation requires the resting of the saw on the workpiece, the saw shall be rested on the larger portion and the smaller piece cut off.

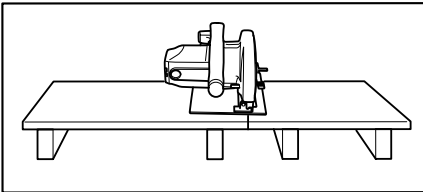

Fig. 1

To avoid kickback, do support board or panel near the cut.

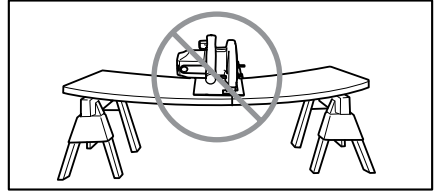

Fig. 2

Do not support board or panel away from the cut.

9. **Use Rip Fence.**  
Always use a fence or straight edge guide when ripping.
10. **Guard Against Kickback. (Fig. 1 & 3)**  
Kickback occurs when the saw stalls rapidly and is driven back towards the operator. Release switch immediately if blade binds or saw stalls. Keep blades sharp. Support large panels as shown in Fig. 1.  
Use fence or straight edge guide when ripping. Don't force tool. Stay alert-exercise control. Don't remove saw from work during a cut while the blade is moving.  
**NEVER** place your hand or fingers behind the saw. If kickback occurs, the saw could easily jump backwards over your hand, possibly causing severe injury.

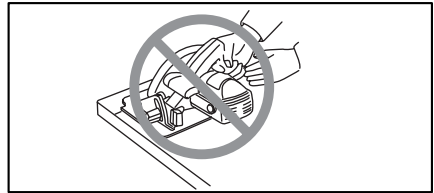

Fig. 3

11. **Lower guard should be retracted manually only for special cuts such as "Compound Cuts".** Raise lower guard by Retracting Lever. As soon as blade enters the material, lower guard must be released. For all other sawing, the lower guard should operate automatically.
12. **Adjustments.**  
Before cutting be sure depth and bevel adjustments are tight.
13. **Use Only Correct Blades In Mounting.**  
Don't use blades with incorrect size holes. Never use defective or incorrect blade washers or bolts.

14. **Avoid Cutting Nails.**

Inspect for and remove all nails from lumber before cutting.

15. When operating the saw, keep the cord away from the cutting area and position it so that it will not be caught on the workpiece during the cutting operation. Operate with proper hand support, proper workpiece support, and supply cord routing away from the work area.

**WARNING:**

It is important to support the workpiece properly and to hold the saw firmly to prevent loss of control which could cause personal injury. Fig. 4 illustrates typical hand support of the saw.

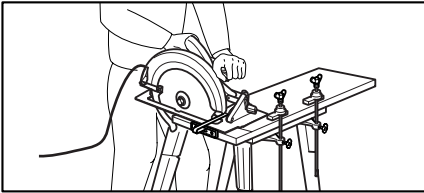

Fig. 4

A typical illustration of proper hand support, workpiece support, and supply cord routing.

16. Place the wider portion of the saw base on that part of the workpiece which is solidly supported, not on the section that will fall off when the cut is made.

As example, Fig. 5 illustrates the **RIGHT** way to cut off the end of a board, and Fig. 6 the **WRONG** way. If the workpiece is short or small, clamp it down. **DON'T TRY TO HOLD SHORT PIECES BY HAND!** (Fig. 6)

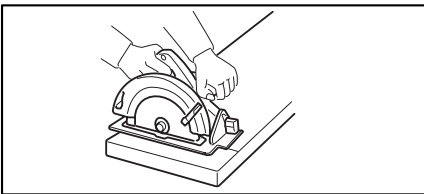

Fig. 5

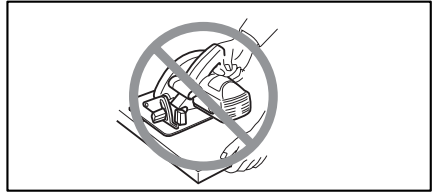

Fig. 6

17. Never attempt to saw with the circular saw held upside down in a vise. This is extremely dangerous and can lead to serious accidents. (Fig. 7)

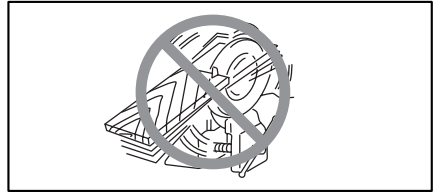

Fig. 7

18. Before setting the tool down after completing a cut, be sure that the lower (telescoping) guard has closed and the blade has come to a complete stop.

19. Using manufacturer data

- Ensure that the diameter, thickness and other characteristics of the saw blade are suitable for the tool.
- Ensure that the saw blade is suitable for the spindle speed of the tool.

20. Do not use any abrasive wheel.

**SAVE THESE INSTRUCTION**

## FUNCTIONAL DESCRIPTION

### ⚠ CAUTION:

- Always be sure that the tool is switched off and unplugged before adjusting or checking function on the tool.

### Adjusting depth of cut

### ⚠ CAUTION:

- Use a shallow depth of cut when cutting thin workpiece for cleaner, safer cutting.
- After adjusting the depth of cut, always tighten the lever securely.

Loosen the lever on the depth guide and move the base up or down. At the desired depth of cut, secure the base by tightening the lever.

004322

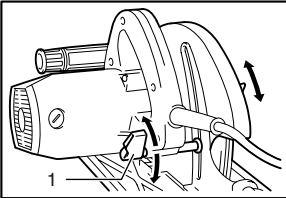

1. Lever

### Bevel cutting

Loosen the clamping screws in front and back, and tilt the tool to the desired angle for bevel cuts ( $0^\circ - 50^\circ$ ). Secure the clamping screws tightly in front and back after making the adjustment.

004323

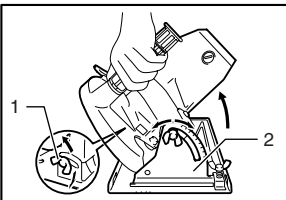

1. Wing nut  
2. Bevel scale plate

### Sighting

For straight cuts, align the A position on the front of the base with your cutting line. For  $45^\circ$  bevel cuts, align the B position with it.

004324

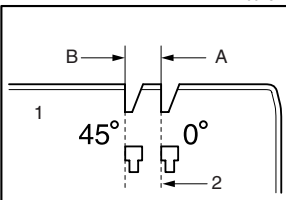

1. Base plate  
2. Cutting line

### Switch action

### ⚠ CAUTION:

- Before plugging in the tool, always check to see that the switch trigger actuates properly and returns to the "OFF" position when released.

#### For tool with lock button

To start the tool, simply pull the switch trigger. Release the switch trigger to stop.

For continuous operation, pull the switch trigger and then push in the lock button.

To stop the tool from the locked position, pull the switch trigger fully, then release it.

004325

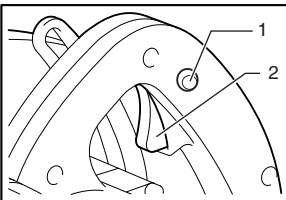

1. Lock button  
2. Switch trigger

## ASSEMBLY

### For tool without lock button

To start the tool, simply pull the switch trigger. Release the switch trigger to stop.

#### CAUTION:

- Always be sure that the tool is switched off and unplugged before carrying out any work on the tool.

### Removing or installing saw blade

#### CAUTION:

- Be sure the blade is installed with teeth pointing up at the front of the tool.
- Use only the Makita wrench to install or remove the blade.

To remove the blade, press the shaft lock so that the blade cannot revolve and use the wrench to loosen the hex bolt counterclockwise. Then remove the hex bolt, outer flange and blade.

To install the blade, follow the removal procedure in reverse. **BE SURE TO TIGHTEN THE HEX BOLT CLOCKWISE SECURELY.**

C00028

The following blade can be used with the tool.

Max. dia.	Min. dia.
235 mm	230 mm

004326

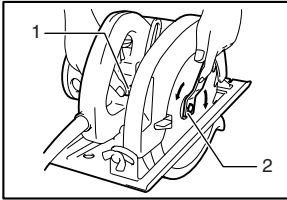

1. Shaft lock
2. Wrench

004327

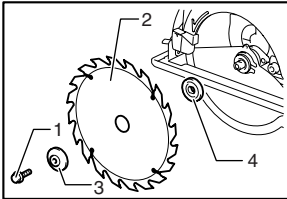

1. Hex bolt
2. Saw blade
3. Outer flange
4. Inner flange

004328

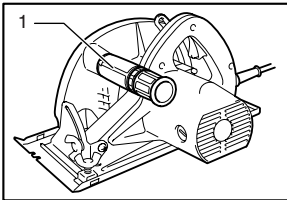

1. Side grip

### Side grip (auxiliary handle)

Install the side grip on the tool securely before operation.

004329

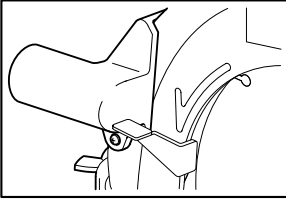

### Joint set (Accessory)

Attach the joint to the chip chute in the blade case and secure it with the screws.

004330

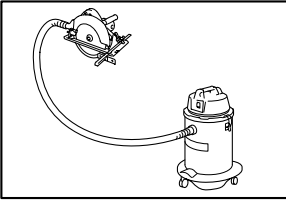

Remove the lever attached to the main unit and attach lever of joint set.

## OPERATION

### ⚠ CAUTION:

- Be sure to move the tool forward in a straight line gently. Forcing or twisting the tool will result in overheating the motor and dangerous kickback, possibly causing severe injury.

004331

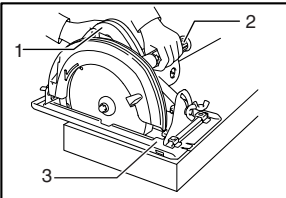

1. Rear handle
2. Front grip
3. Base

Hold the tool firmly. The tool is provided with both a front grip and rear handle. Use both to best grasp the tool. If both hands are holding saw, they cannot be cut by the blade. Set the base on the workpiece to be cut without the blade making any contact. Then turn the tool on and wait until the blade attains full speed. Now simply move the tool forward over the workpiece surface, keeping it flat and advancing smoothly until the sawing is completed. To get clean cuts, keep your sawing line straight and your speed of advance uniform. If the cut fails to properly follow your intended cut line, do not attempt to turn or force the tool back to the cut line. Doing so may bind the blade and lead to dangerous kickback and possible serious injury. Release switch, wait for blade to stop and then withdraw tool. Realign tool on a new cut line, and start cut again. Attempt to avoid positioning which exposes operator to chips and wood dust being ejected from saw. Use eye protection to help avoid injury.

004332

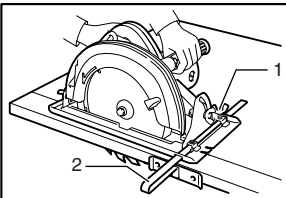

1. Wing nut
2. Guide rule

### Rip fence (Guide rule)

The handy rip fence allows you to do extra-accurate straight cuts. Simply slide the rip fence up snugly against the side of the workpiece and secure it in position with the screw on the front of the base. It also makes repeated cuts of uniform width possible.



## MAINTENANCE

**⚠ CAUTION:**

- Always be sure that the tool is switched off and unplugged before attempting to perform inspection or maintenance.

### Replacing carbon brushes

Remove and check the carbon brushes regularly. Replace when they wear down to the limit mark. Keep the carbon brushes clean and free to slip in the holders. Both carbon brushes should be replaced at the same time. Use only identical carbon brushes.

Use a screwdriver to remove the brush holder caps. Take out the worn carbon brushes, insert the new ones and secure the brush holder caps.

To maintain product SAFETY and RELIABILITY, repairs, any other maintenance or adjustment should be performed by Makita Authorized Service Centers, always using Makita replacement parts.

001145

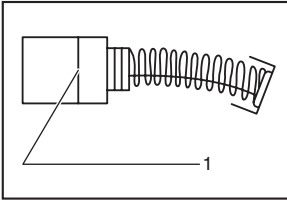

1. Limit mark

004375

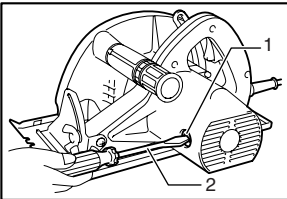

1. Brush holder cap  
2. Screwdriver

## ACCESSORIES

**⚠ CAUTION:**

- These accessories or attachments are recommended for use with your Makita tool specified in this manual. The use of any other accessories or attachments might present a risk of injury to persons. Only use accessory or attachment for its stated purpose.

If you need any assistance for more details regarding these accessories, ask your local Makita service center.

- Saw blades
- Rip fence (Guide rule)
- Offset wrench 13
- Grip 36
- Joint set





Makita Corporation Japan