

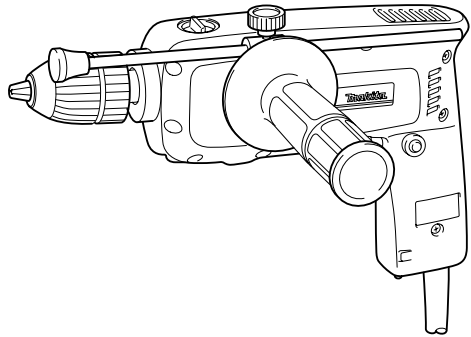

# 2-speed drill

MODEL 6310



004610



## INSTRUCTION MANUAL

**⚠ WARNING:**

For your personal safety, READ and UNDERSTAND before using.  
SAVE THESE INSTRUCTIONS FOR FUTURE REFERENCE.

# SPECIFICATIONS

Model		6310	
Capacities	Steel	Hi: 8 mm	Lo: 13 mm
	Wood	Hi: 20 mm	Lo: 32 mm
No load speed (min <sup>-1</sup> )		Hi: 0 - 2000	Lo: 0 - 700
Overall length		310 mm	
Net weight		2 kg	
Safety class		□ /II	

- Due to our continuing programme of research and development, the specifications herein are subject to change without notice.
- Note: Specifications may differ from country to country.

## SYMBOLS

END201-2

The following show the symbols used for the equipment. Be sure that you understand their meaning before use.



.....Read instruction manual.



.....DOUBLE INSULATION



.....Only for EU countries

Do not dispose of electric equipment together with household waste material!

In observance of European Directive 2002/96/EC on waste electric and electronic equipment and its implementation in accordance with national law, electric equipment that have reached the end of their life must be collected separately and returned to an environmentally compatible recycling facility.

## Intended use

The tool is intended for drilling in wood, metal and plastic.

## Power supply

The tool should be connected only to a power supply of the same voltage as indicated on the nameplate, and can only be operated on single-phase AC supply. They are double-insulated in accordance with European Standard and can, therefore, also be used from sockets without earth wire.

## For European countries only

### Noise and Vibration

The typical A-weighted sound pressure level is 80 dB (A). Uncertainty is 3 dB(A).

The noise level under working may exceed 85 dB (A).

– Wear ear protection. –

The typical weighted root mean square acceleration value is not more than 2.5 m/s<sup>2</sup>.

These values have been obtained according to EN60745.

### EC-DECLARATION OF CONFORMITY

We declare under our sole responsibility that this product is in compliance with the following standards of standardized documents, EN60745, EN55014, EN61000 in accordance with Council Directives, 89/336/EEC, 98/37/EC.

Yasuhiko Kanzaki **CE 2005**

Director

### MAKITA INTERNATIONAL EUROPE LTD.

Michigan Drive, Tongwell, Milton Keynes, Bucks MK15 8JD, ENGLAND

Responsible manufacturer:

Makita Corporation Anjo Aichi Japan

---

# GENERAL SAFETY RULES

GEA001-3

## WARNING:

**Read all instructions.** Failure to follow all instructions listed below may result in electric shock, fire and/or serious injury. The term “power tool” in all of the warnings listed below refers to your mains-operated (corded) power tool or battery-operated (cordless) power tool.

---

## SAVE THESE INSTRUCTIONS

### Work area safety

1. **Keep work area clean and well lit.** Cluttered and dark areas invite accidents.
2. **Do not operate power tools in explosive atmospheres, such as in the presence of flammable liquids, gases or dust.** Power tools create sparks which may ignite the dust or fumes.
3. **Keep children and bystanders away while operating a power tool.** Distractions can cause you to lose control.

### Electrical safety

4. **Power tool plugs must match the outlet. Never modify the plug in any way. Do not use any adapter plugs with earthed (grounded) power tools.** Unmodified plugs and matching outlets will reduce risk of electric shock.
5. **Avoid body contact with earthed or grounded surfaces such as pipes, radiators, ranges and refrigerators.** There is an increased risk of electric shock if your body is earthed or grounded.
6. **Do not expose power tools to rain or wet conditions.** Water entering a power tool will increase the risk of electric shock.
7. **Do not abuse the cord. Never use the cord for carrying, pulling or unplugging the power tool. Keep cord away from heat, oil, sharp edges or moving parts.** Damaged or entangled cords increase the risk of electric shock.
8. **When operating a power tool outdoors, use an extension cord suitable for outdoor use.** Use of a cord suitable for outdoor use reduces the risk of electric shock.

### Personal safety

9. **Stay alert, watch what you are doing and use common sense when operating a power tool. Do not use a power tool while you are tired or under the influence of drugs, alcohol or medication.** A moment of inattention while operating power tools may result in serious personal injury.

10. **Use safety equipment. Always wear eye protection.** Safety equipment such as dust mask, non-skid safety shoes, hard hat, or hearing protection used for appropriate conditions will reduce personal injuries.
11. **Avoid accidental starting. Ensure the switch is in the off-position before plugging in.** Carrying power tools with your finger on the switch or plugging in power tools that have the switch on invites accidents.
12. **Remove any adjusting key or wrench before turning the power tool on.** A wrench or a key left attached to a rotating part of the power tool may result in personal injury.
13. **Do not overreach. Keep proper footing and balance at all times.** This enables better control of the power tool in unexpected situations.
14. **Dress properly. Do not wear loose clothing or jewellery. Keep your hair, clothing, and gloves away from moving parts.** Loose clothes, jewellery or long hair can be caught in moving parts.
15. **If devices are provided for the connection of dust extraction and collection facilities, ensure these are connected and properly used.** Use of these devices can reduce dust-related hazards.

### Power tool use and care

16. **Do not force the power tool. Use the correct power tool for your application.** The correct power tool will do the job better and safer at the rate for which it was designed.
17. **Do not use the power tool if the switch does not turn it on and off.** Any power tool that cannot be controlled with the switch is dangerous and must be repaired.
18. **Disconnect the plug from the power source and/or the battery pack from the power tool before making any adjustments, changing accessories, or storing power tools.** Such preventive safety measures reduce the risk of starting the power tool accidentally.

- 
19. **Store idle power tools out of the reach of children and do not allow persons unfamiliar with the power tool or these instructions to operate the power tool.** Power tools are dangerous in the hands of untrained users.
  20. **Maintain power tools. Check for misalignment or binding of moving parts, breakage of parts and any other condition that may affect the power tools operation. If damaged, have the power tool repaired before use.** Many accidents are caused by poorly maintained power tools.
  21. **Keep cutting tools sharp and clean.** Properly maintained cutting tools with sharp cutting edges are less likely to bind and are easier to control.
  22. **Use the power tool, accessories and tool bits etc. in accordance with these instructions and in**

**the manner intended for the particular type of power tool, taking into account the working conditions and the work to be performed.** Use of the power tool for operations different from those intended could result in a hazardous situation.

#### **Service**

23. **Have your power tool serviced by a qualified repair person using only identical replacement parts.** This will ensure that the safety of the power tool is maintained.
24. **Follow instruction for lubricating and changing accessories.**
25. **Keep handles dry, clean and free from oil and grease.**

---

## **SPECIFIC SAFETY RULES**

GEB001-2

**DO NOT let comfort or familiarity with product (gained from repeated use) replace strict adherence to drill safety rules. If you use this power tool unsafely or incorrectly, you can suffer serious personal injury.**

1. **Use auxiliary handles supplied with the tool.** Loss of control can cause personal injury.
2. **Hold power tools by insulated gripping surfaces when performing an operation where the cutting tool may contact hidden wiring or its own cord.** Contact with a "live" wire will make exposed metal parts of the tool "live" and shock the operator.
3. **Always be sure you have a firm footing. Be sure no one is below when using the tool in high locations.**
4. **Hold the tool firmly.**
5. **Keep hands away from rotating parts.**
6. **Do not leave the tool running. Operate the tool only when hand-held.**
7. **Do not touch the drill bit or the workpiece immediately after operation; they may be extremely hot and could burn your skin.**
8. **Some material contains chemicals which may be toxic. Take caution to prevent dust inhalation and skin contact. Follow material supplier safety data.**

---

## **SAVE THESE INSTRUCTIONS**

** WARNING:**  
**MISUSE or failure to follow the safety rules stated in this instruction manual may cause serious personal injury.**

## FUNCTIONAL DESCRIPTION

004620

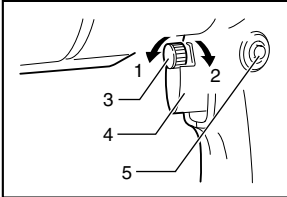

1. Low
2. High
3. Speed control screw
4. Switch trigger
5. Lock button

### ⚠ CAUTION:

- Always be sure that the tool is switched off and unplugged before adjusting or checking function on the tool.

### Switch action

### ⚠ CAUTION:

- Before plugging in the tool, always check to see that the switch trigger actuates properly and returns to the "OFF" position when released.

To start the tool, simply pull the switch trigger. Tool speed is increased by increasing pressure on the switch trigger. Release the switch trigger to stop. For continuous operation, pull the switch trigger and then push in the lock button.

To stop the tool from the locked position, pull the switch trigger fully, then release it.

A speed control screw is provided so that maximum tool speed can be limited (variable).

Turn the speed control screw clockwise for higher speed, and counterclockwise for lower speed.

004627

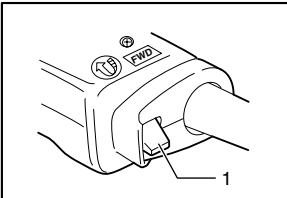

1. Reversing switch lever

### Reversing switch action

This tool has a reversing switch to change the rotational direction. Move the reversing switch lever to the "FWD" position for clockwise (forward) rotation or the "REV" position for counterclockwise (reverse) rotation.

### ⚠ CAUTION:

- Always check the rotational direction before operation.
- Use the reversing switch only after the tool comes to a complete stop. It will damage the tool to change the rotational direction before the tool stops.

004631

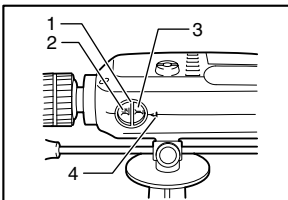

1. Speed change knob
2. 0 - 2000 min<sup>-1</sup>
3. 0 - 700 min<sup>-1</sup>
4. Arrow

### Speed change

To change the tool speed, turn the speed change knob so that the reference arrow on the tool body points to the desired speed indication.

### ⚠ CAUTION:

- Use the speed change knob only after the tool comes to a complete stop. Changing the tool speed before the tool stops may damage the tool.

## ASSEMBLY

### ⚠ CAUTION:

- Always be sure that the tool is switched off and unplugged before carrying out any work on the tool.

004634

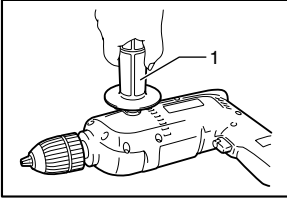

1. Side grip

## Installing side grip (auxiliary handle)

### ⚠ CAUTION:

- Always be sure that the side grip is installed securely before operation. Screw the side grip on the tool securely.

## Installing or removing drill bit

004640

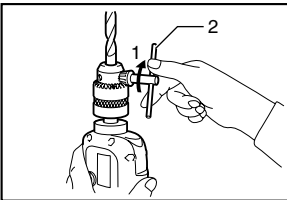

1. Tighten
2. Chuck key

### For tool with standard keyed chuck

To install the bit, place it in the chuck as far as it will go. Tighten the chuck by hand. Place the chuck key in each of the three holes and tighten clockwise. Be sure to tighten all three chuck holes evenly.

To remove the bit, turn the chuck key counterclockwise in just one hole, then loosen the chuck by hand.

After using the chuck key, be sure to return to the original position.

004646

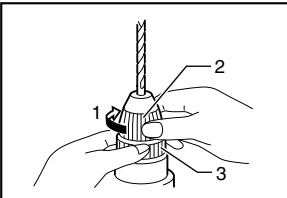

1. Tighten
2. Sleeve
3. Ring

### For tool with keyless chuck

Hold the ring and turn the sleeve counterclockwise to open the chuck jaws. Place the bit in the chuck as far as it will go. Hold the ring firmly and turn the sleeve clockwise to tighten the chuck.

To remove the bit, hold the ring and turn the sleeve counterclockwise.

004653

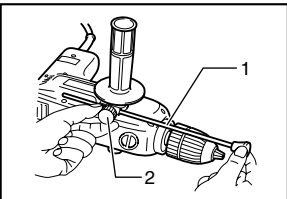

1. Depth gauge
2. Screw

## Depth gauge

The depth gauge is convenient for drilling holes of uniform depth. Loosen the screw and adjust the depth gauge to the desired depth. After adjusting, tighten the screw.

---

## OPERATION

### Drilling operation

#### Drilling in wood

When drilling in wood, the best results are obtained with wood drills equipped with a guide screw. The guide screw makes drilling easier by pulling the bit into the workpiece.

#### Drilling in metal

To prevent the bit from slipping when starting a hole, make an indentation with a center-punch and hammer at the point to be drilled. Place the point of the bit in the indentation and start drilling.

Use a cutting lubricant when drilling metals. The exceptions are iron and brass which should be drilled dry.

 **CAUTION:**

- Pressing excessively on the tool will not speed up the drilling. In fact, this excessive pressure will only serve to damage the tip of your bit, decrease the tool performance and shorten the service life of the tool.
- There is a tremendous twisting force exerted on the tool/bit at the time of hole breakthrough. Hold the tool firmly and exert care when the bit begins to break through the workpiece.
- A stuck bit can be removed simply by setting the reversing switch to reverse rotation in order to back out. However, the tool may back out abruptly if you do not hold it firmly.
- Always secure small workpieces in a vise or similar hold-down device.
- Avoid drilling in material that you suspect contains hidden nails or other things that may cause the bit to bind or break.

## MAINTENANCE

 **CAUTION:**

- Always be sure that the tool is switched off and unplugged before attempting to perform inspection or maintenance.

To maintain product SAFETY and RELIABILITY, repairs, carbon brush inspection and replacement, any other maintenance or adjustment should be performed by Makita Authorized Service Centers, always using Makita replacement parts.

## ACCESSORIES

 **CAUTION:**

- These accessories or attachments are recommended for use with your Makita tool specified in this manual. The use of any other accessories or attachments might present a risk of injury to persons. Only use accessory or attachment for its stated purpose.

If you need any assistance for more details regarding these accessories, ask your local Makita service center.

- Drill bits
- Keyless drill chuck
- Grip 36
- Depth gauge

Makita Corporation Anjo, Aichi, Japan